

SHARP®

UA-HG60E

UA-HG50E

UA-HG40E



HIGH-DENSITY 7000*

"Plasmacluster" and "Device of a cluster of grapes" are trademarks of Sharp Corporation.



Free standing Type

AIR PURIFIER
with Humidifying Function
OPERATION MANUAL

ENGLISH

* The number in this technology mark indicates an approximate number of ions supplied into air of 1 cm³, which is measured around the center of a room with the "high-density plasmacluster 7000" applicable floor area (at 1.2 m height above the floor) when the product is placed close to a wall at the MED mode setting.

FEATURES

A unique Combination of Air Treatment Technologies
Triple Filtration System + Plasmacluster + Humidification

TRAPS DUST
 Pre-filter traps dust larger than approx 240 micron particles.

DECREASES ODOURS
 Deodorizing filter absorbs harmful gases*1 and many common household odours.

REDUCES TINY DUST, POLLEN & MOLD*2
 HEPA filter traps 99.97% of particles as small as 0.3 microns.

FRESHENS
 By emitting a balance of positive and negative ions, Plasmacluster air treatment is a natural process.

HUMIDIFIES
 Controls humidity by sensing temperature and humidity automatically.

*1: VOC, NOx, SOx. The deodorizing performance for a single component odours substance in a 1m³ test container may be different than the deodorizing performance in actual use.

*2: When air is circulated through the filter system.

Sensor Technology continuously monitors air quality and room condition, and automatically adjusts operation.

INTELLIGENT MODE

(UA-HG60E / UA-HG50E)

6 sensors sensing 7 factors precisely control automatic operation.



7 detection by 6 sensors

SENSOR	DETECTION
Dust (sensitive)	PM2.5 (particulate matter less than 2.5 microns), etc.
	Tobacco smoke, house dust (dirt, mite feces and remains, mold spores, pollen)
Odour	Tobacco, cosmetic, alcohol, spray, and other odours
Temperature	Room temperature
Humidity	Room humidity
Light	Room brightness
Motion*3	Movement of persons or pets

*3: Senses only when Intelligent mode is in operation.

When a person or pet is in the sensory area*4
 (*4: Ref.E-5)

- When there is little movement of a person or pet (example: when sleeping), automatically switches to quiet air flow.
- When the room is dark, the Front Display, Cleanliness Monitor and Air Outlet LED turn off automatically.

When there is no movement in the sensory area

- The Front Display, Cleanliness Monitor and Air Outlet LED turn off, humidifying stops, and the unit switches to minimum airflow to save power consumption.
- When room humidity is over 80% and the room is bright, Plasmacluster Ions are emitted with strong airflow.

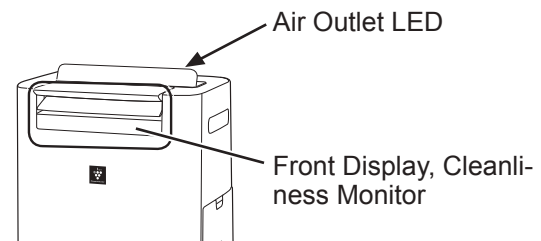

NOTE

- When in Intelligent mode you can manually switch humidifying ON or OFF (Ref. E-8)
- Front Display and Air Outlet LED automatically switch ON and OFF based on room brightness. (When light control is set to "Auto". Ref. E-11)
- When the Motion Sensor senses that no one has been in the room for a set interval of time it determines that the room is unoccupied.
- You can change brightness of Display / Monitor, sensor sensitivity, and Motion Sensor sensing time. (Ref. E-11, E-12)
- Motion sensor may sense movement other than persons or pets. (waving curtain etc.)

Please read before operating your new Air Purifier

The air purifier draws in room air through the air intake, circulates it through a Pre-Filter, a Deodorizing Filter and a HEPA Filter inside the unit, and then discharges it through the air outlet. The HEPA Filter can remove 99.97% of dust particles as small as 0.3 microns that pass through the filter and also helps absorb odours. The Deodorizing Filter gradually absorbs odours as they pass through the filter.

Some odours absorbed by the filters will break down over time, causing additional odours. Depending on usage conditions, and especially if the unit is used in environments significantly more severe than a normal household, these odours may become noticeable sooner than expected. If these odours persist, replace the filters. (Ref. E-15)

When minerals in tap water adhere to the filters and become a hard and white, they absorb odours in the room that can cause the emission of an unpleasant odour when the humidifying filter is dry. (Varies depending on water quality and other environmental factors) If this occurs, perform humidifying filter maintenance. (Ref. E-14)

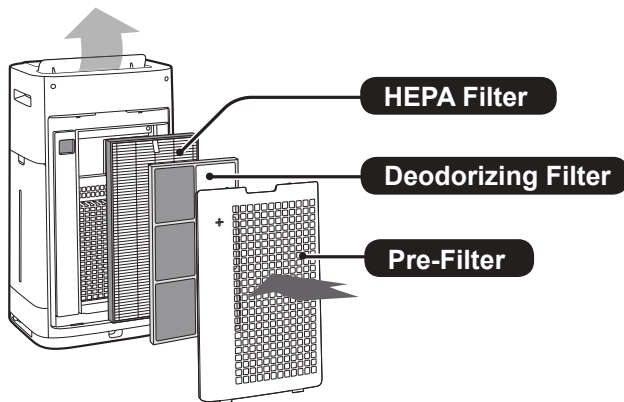

NOTE

- The air purifier is designed to remove air-suspended dust and the odours.
The air purifier is not designed to remove harmful gases such as carbon monoxide contained in cigarette smoke. The air purifier may not completely remove an odour if the source of the odour is still present.

CONTENTS

IMPORTANT SAFETY INSTRUCTIONS ...E-3

- WARNING
- NOTE
- CAUTIONS CONCERNING OPERATION
- INSTALLATION GUIDELINES
- FILTER GUIDELINES

PART NAMES.....E-5

- FRONT
- BACK
- OPERATION PANEL
- FRONT DISPLAY

PREPARATIONE-7

- FILTER INSTALLATION

OPERATIONE-7

- START / STOP
- CLEAN ION SHOWER MODE
- INTELLIGENT MODE (UA-HG60E / UA-HG50E)
- AUTO MODE (UA-HG40E)
- PLASMACLUSTER ION SPOT MODE
- SELECTING MODE
- CHILD LOCK
- HUMIDIFICATION SETTING (REFILLING THE WATER TANK)
- ON TIMER
- OFF TIMER
- SELECTING DISPLAY
- PLASMACLUSTER ION ON / OFF
- PATROLLING FUNCTION
- HOW TO CHANGE VARIOUS SETTINGS

CARE AND MAINTENANCEE-13

- FILTER INDICATOR
- CARE INDEX
- WATER TANK
- UNIT / BACK PANEL
- HUMIDIFYING FILTER AND TRAY
- HEPA FILTER / DEODORIZING FILTER
- FILTER REPLACEMENT

TROUBLESHOOTINGE-16

SPECIFICATIONS.....E-17

Thank you for purchasing this SHARP Air Purifier. Please read this manual carefully before using the air purifier. After reading, keep the manual in a convenient location for future reference.

IMPORTANT SAFETY INSTRUCTIONS

Always follow basic safety precautions when using electrical appliances, including the following:

WARNING – Always observe the following to reduce the risk of electrical shock, fire, or injury:

- Read all instructions before using the unit.
- Use only a 220-240 volt outlet.
- **This appliance can be used by children aged from 8 years and above and persons with reduced physical, sensory or mental capabilities or lack of experience and knowledge if they have been given supervision or instruction concerning use of the appliance in a safe way and understand the hazards involved. Children shall not play with the appliance. Cleaning and user maintenance shall not be made by children without supervision.**
- **If the power cord is damaged, it must be replaced by the manufacturer, its service agent, a Sharp authorized Service Centre or similarly qualified persons in order to avoid a hazard.**
- **Be sure to remove the power plug when refilling the Water Tank, before performing maintenance, when removing and attaching and replacing the filter and when not using for a long time. Failure to do so can cause a short circuit resulting in electrical shock or fire.**
- Do not use the unit if the power cord or plug is damaged or if the connection to the wall outlet is loose.
- Periodically remove dust from the plug.
- Do not insert fingers or foreign objects into the air intake or air outlet.
- When removing the power plug, always hold the plug and never pull on the cord. Failure to do so can cause a short circuit resulting in electrical shock or fire.
- When removing the unit, do not damage the power cord with the casters. Failure to do so can cause electric shock, heat generation, or fire.
- Be careful not to damage the power cord, it may cause electric shock, excess heat or fires.
- Do not remove the plug when your hands are wet.
- Do not place the unit near gas appliances or fireplaces.

- Only a Sharp Authorized Service Centre should service this air purifier. Contact the nearest Service Centre for any problems, adjustments, or repairs.
- Do not operate the unit in rooms where aerosol insecticides are present. Do not operate the unit in rooms where there is oily residue, incense, sparks from lit cigarettes, or chemical fumes in the air. Do not operate the unit in places where it may get wet, such as a bathroom.
- Be cautious when cleaning the unit. Strong corrosive cleansers can damage the exterior.
- When carrying the unit, first remove the Water Tank and Humidifying Tray, and then hold the unit by the handles on both sides.
- Do not drink the water in the Humidifying Tray or Water Tank.
- Do not expose the unit to water. Doing so can cause a short circuit or electrical shock.
- Replace the water in the Water Tank daily with fresh tap water, and regularly clean the Water Tank and Humidifying Tray (see E-8, E-13, E-14). When the unit is not in use, dispose of the water in the Water Tank and Humidifying Tray. Leaving water in the Water Tank or Humidifying Tray can cause mold, bacteria, and bad odours. In rare cases, such bacteria can be a health hazard.

NOTE – What to do if the unit interferes with radio or TV reception

If the air purifier interferes with radio or television reception, try one or more of the following measures:

- Adjust or reposition the receiving antenna.
- Increase the distance between the unit and the radio or TV.
- Connect the equipment into an outlet on a circuit different from that of the radio or TV receiver.
- Consult the dealer or a qualified radio or TV technician.

CAUTIONS CONCERNING OPERATION

- Do not block the air intake or air outlet.
- Do not place the unit near or on hot objects, such as stoves or heaters, or where it may come into contact with steam.

- Always operate the unit in an upright position.
- When moving the unit, use the handles on both sides.
Do not move the unit when it is in operation.
- If the unit is on easily damaged flooring, an uneven surface, or thick-piled carpet, lift it up when moving.
- When moving the unit by its casters, move it slowly and in a horizontal direction.
- Turn the unit off and remove the water tank before moving, take care not to catch your fingers.
- Do not operate the unit without the filters, the Water Tank, and the Humidifying Tray properly installed.
- Do not wash and reuse the HEPA filter and the Deodorizing filter.
Doing so will not improve filter performance and can also cause electric shock or operating malfunctions.
- Clean the exterior with a soft cloth only. Do not use volatile fluids or detergents. The unit surface may be damaged or cracked with Benzene paint thinner or polishing powder. In addition, the sensors may malfunction as a result.
- The frequency of descaling maintenance will depend on the hardness of and the impurities in the water that you use; the harder the water the more often descaling will be necessary.
- Keep the unit away from water.
- When refilling the Water Tank, make sure of no water leaking from the Water Tank.
- Be sure to wipe off any excess water on the outside of the Water Tank.
- Do not use hot water (40 °C or more), chemical agents, aromatic substances, dirty water, or other damaging substances. Doing so can deform the unit or cause it to malfunction.
- Use only fresh tap water. Using other water sources risks the growth of molds, fungi, or bacteria.
- Do not shake the Water Tank with holding the carrying handle.
- Do not remove the Humidifying Filter from the filter frame except when replacing it.
- Avoid spilling water when removing or cleaning the Humidifying Tray.
- Do not remove the Float.
If it comes off, refer to E-15.
- Do not use the detergents for maintenance of the Humidifying Tray and Cover.
If cause deformation, tarnishing, cracking (water leakage).

- Do not scrub the Back Panel hard during its maintenance.

INSTALLATION GUIDELINES

- Avoid locations where the sensors are exposed to direct wind.
Doing so can cause the unit to malfunction.
- Avoid locations where furniture, fabrics, or other objects can come in contact with the unit and interfere with the intake and outtake of air.
- Avoid locations where the unit is exposed to condensation or drastic changes in temperature. Appropriate room temperature is between 0 – 35 °C.
- Place the unit on a level and stable surface with sufficient air circulation.
When placed on heavy carpet, the unit may vibrate slightly.
Place the unit on a level surface to avoid water leakage from the Water Tank and Humidifying Tray.
- Avoid locations that generate grease or oily smoke.
Doing so can cause the unit exterior to crack and the sensors to malfunction.
- The dust collecting ability of the unit is effective even when the unit is as close to 3 cm from the wall, the surrounding walls and floor may get dirty. Please place the unit at a distance from the wall.
The wall directly behind the air outlet may become dirty over time. When using the unit for an extended period of time at the same location, periodically clean the walls adjacent to it.

FILTER GUIDELINES

- Follow the instructions in this manual for proper filter care and maintenance. (Ref. E-13, E-14, E-15)

PART NAMES

FRONT

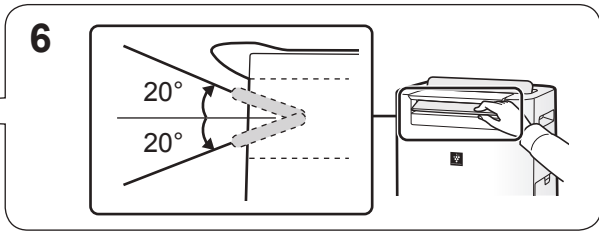
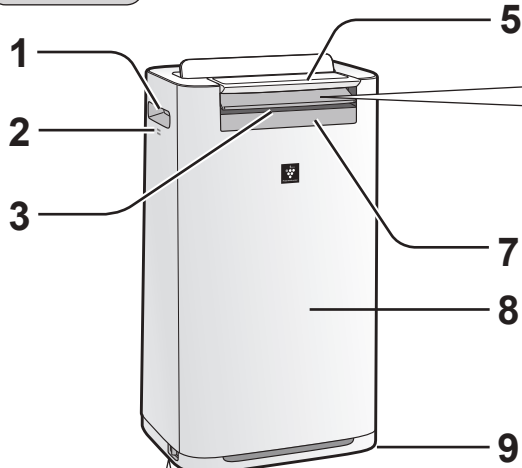

4 To Lock a caster stopper (Right & Left)

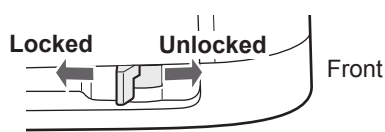

1	Handle (2 Locations)
2	Sensor (Internal) Temperature / Humidity / Odour* (*UA-HG60E / UA-HG50E)
3	Air Outlet (Front)
4	Caster Stopper (Right & Left)
5	Operation Panel
6	Front Louver (Adjustable)
7	Front Display
8	Unit
9	Caster (4 Locations)

BACK

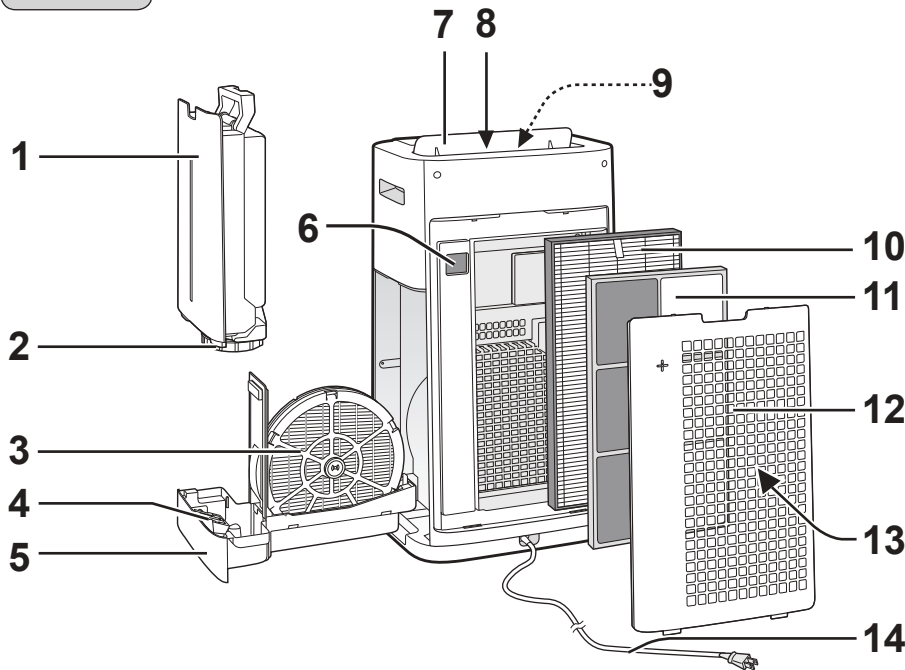

(Plug shape varies by country.)

1	Water Tank	7	Back Louver
2	Tank Cap	8	Air Outlet (Back)
3	Humidifying Filter	9	Air Outlet LED(White)
4	Float	10	HEPA Filter
5	Humidifying Tray	11	Deodorizing Filter
6	Dust(sensitive) Sensor / Sensor Filter	12	Back Panel (Pre-Filter)
		13	Air Inlet
		14	Power Cord / Plug

Detection range

Light Sensor

Do not install the unit in the following places.
The Light Sensor may not sense correctly.

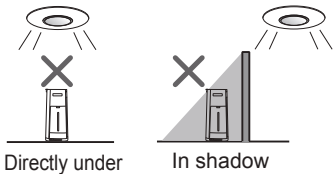

Motion Sensor (UA-HG60E / UA-HG50E)

Sensory range is the area shown below.

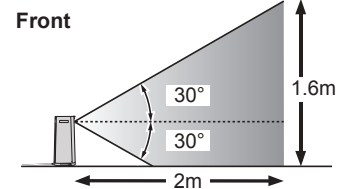

Right and Left

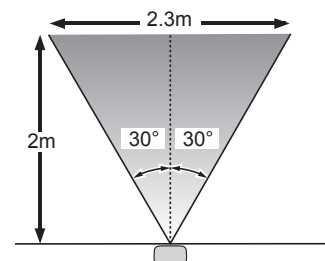

OPERATION PANEL

Press the button with "★" to start.

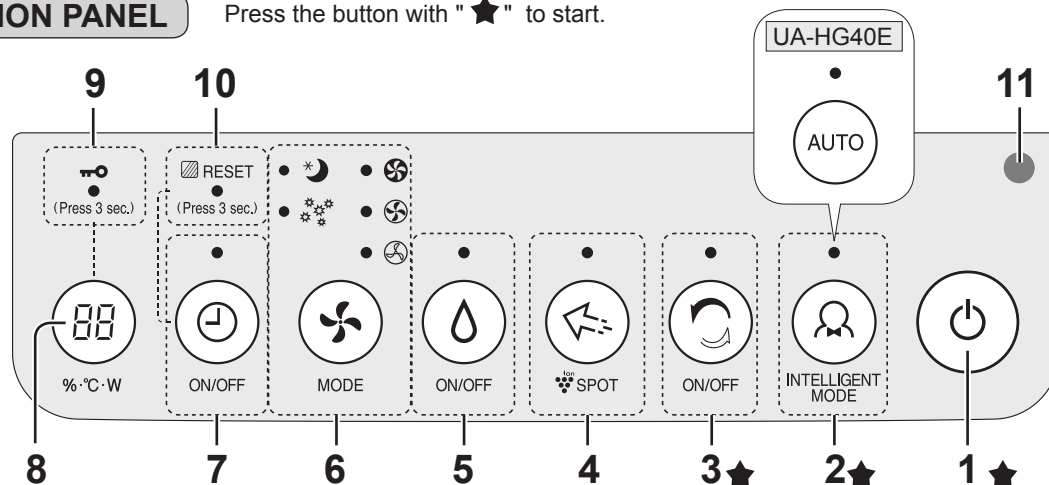

1	POWER ON / OFF Button	7	ON / OFF TIMER Button, Indicator Light (White) <Press 3 sec.> FILTER RESET Button
2	INTELLIGENT MODE Button, Indicator Light (White)	8	DISPLAY SELECT Button <Press 3 sec.> CHILD-LOCK Button
3	CLEAN ION SHOWER Button, Indicator Light (White)	9	CHILD-LOCK Indicator Light (White)
4	Plasmacluster Ion SPOT Button, Indicator Light (White)	10	FILTER RESET Indicator Light (Orange)
5	HUMIDIFY ON / OFF Button, Indicator Light (White)	11	Light Sensor
6	MODE Button, Indicator Light (White)		

FRONT DISPLAY

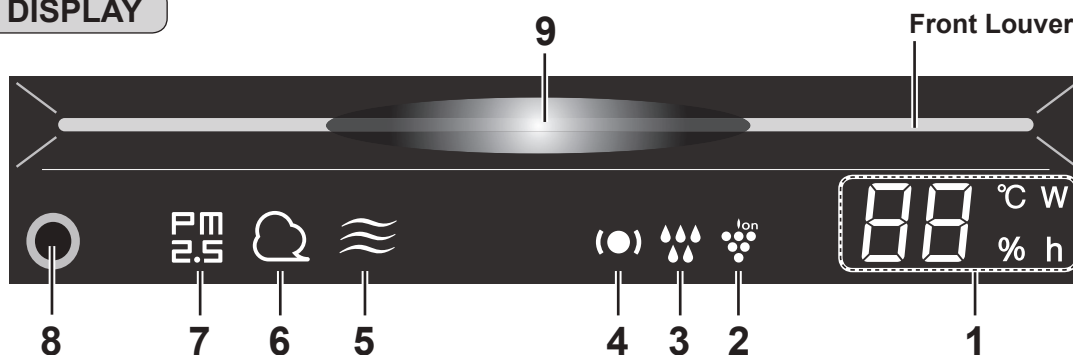

1	Humidity / Temperature Monitor Indicates the approximate humidity level or temperature in the room. The humidity setting cannot be adjusted. Humidity 20% to 90% is displayed. 20% or less 20 % ← 55 % → 90 % 90% or more Temperature 0°C to 50°C is displayed. -1°C or less Lo °C ← 25 °C → Hi °C 50°C or more	4	Patrolling Light (Green / Orange / Red) (Ref.E-9, E-10)
	Wattage Monitor Indicates wattage by current operation. Timer Monitor Indicates setting time or remaining time of ON/OFF timer.	5	Odour Light (White) (UA-HG60E / UA-HG50E) Indicates the Odour Sensor detects odours.
2	Plasmacluster Ion Light (Blue)	6	Dust Light (White) Indicates the Dust(sensitive) Sensor detects usual dust.
3	Humidify Light Green Humidity ON Off Humidity OFF Red(Flashing) Unit needs water	7	PM2.5 Light (White) Indicates the Dust(sensitive) Sensor detects microscopic dust. (particulate matter less than 2.5 microns)
		8	Motion Sensor (UA-HG60E / UA-HG50E)
		9	Cleanliness Monitor Indicates the air purity of the room in 7 levels with colour changes. Blue ↔ Red Clean ↔ Impure

PREPARATION

Always be sure to remove the power plug from the wall outlet.



FILTER INSTALLATION

1 Remove the Back Panel.

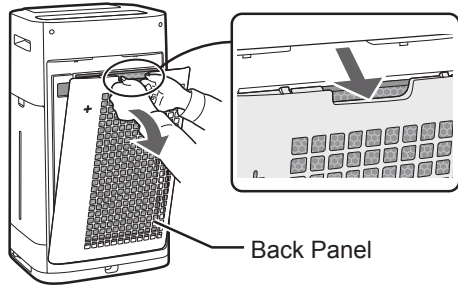

2 Remove the plastic bag from the each filter.

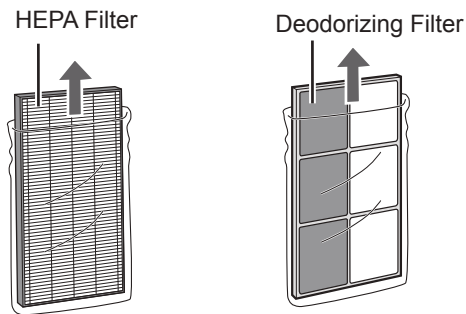

3 Install the filters in the correct order as shown.

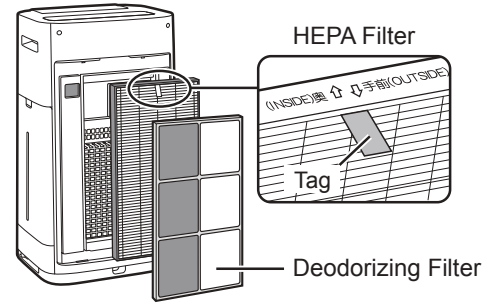

4 Install the Back Panel.

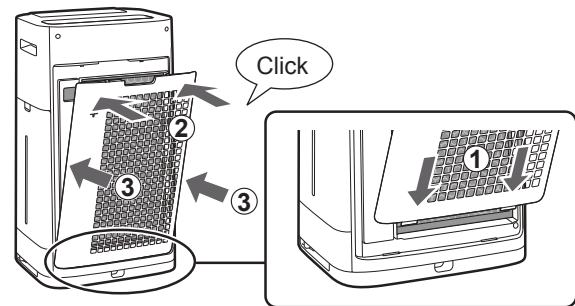

NOTE

- When replacing the filter, making a memo of the start of use date is recommended.

OPERATION

START/STOP

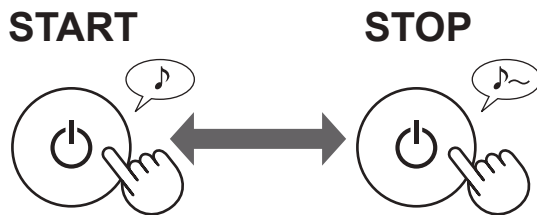

CLEAN ION SHOWER MODE

The unit releases Plasmacluster ions with strong airflow and collects dusts while decreasing static electricity for 10 minutes. After that, the DUST sensor sensitivity is automatically set to "HIGH" and quickly detects impurities and clean the air powerfully for 50 minutes.



ON/OFF

NOTE

- When the operation finishes after 60 minutes, the unit will return to the prior operation mode. It is able to change the other mode during this mode.
- The Plasmacluster Ion can not be turned "OFF". (Ref. E-10)

INTELLIGENT MODE (UA-HG60E / UA-HG50E)

The fan speed is automatically controlled depending on the 7 detection. (Ref. E-1)

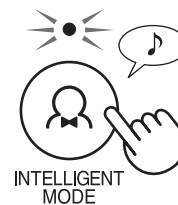

INTELLIGENT MODE

AUTO MODE (UA-HG40E)

The fan speed is automatically controlled depending on the 5 detection. (PM2.5 / Usual dust / Temperature / Humidity / Light)

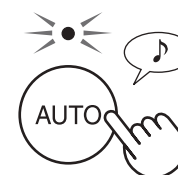

AUTO

NOTE

- Front Display, Cleanliness Monitor and Air Outlet LED automatically switch ON and OFF based on room brightness. (When light control is set to "Auto". Ref. E-11)

PLASMACLUSTER ION SPOT MODE

Use this mode when you want to remove adhering odour, germs, and other substances from cloths, sofas and curtains.

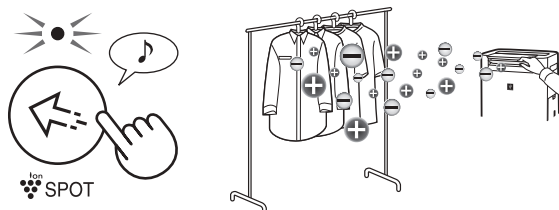

NOTE

Adjust Front Louver manually.

- Emits highdensity Plasmacluster Ions only in the forward direction.
- Discharges stronger air for 8 hours. When the operation finishes, the unit will return to its prior operation mode.
- The Plasmacluster Ion can not be turned "OFF". (Ref.E-10)

SELECTING MODE

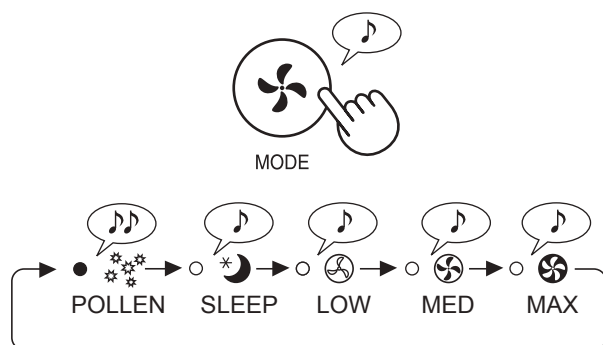

NOTE

SLEEP

The unit will operate quietly, and the fan speed is automatically switched depending on the amount of impurities in the air.

The Front Display, Cleanliness Monitor and Air Outlet LED go off automatically.
(When light control is set to "Auto". Ref.E-11)

POLLEN

The DUST SENSOR sensitivity is automatically set to "HIGH" and quickly detects impurities such as dust and pollen and clean the air powerfully.

CHILD LOCK

Operation of the operation panel will be locked.

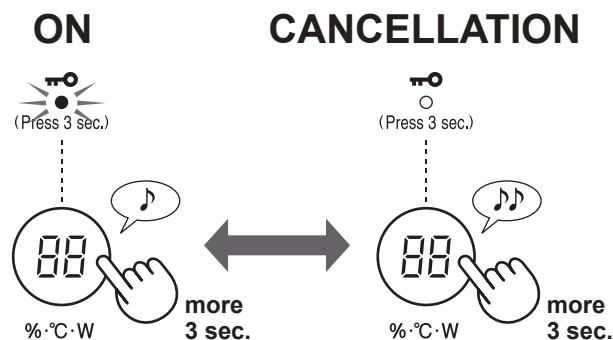

HUMIDIFICATION SETTING

REFILLING THE WATER TANK

1 Remove the Water Tank.

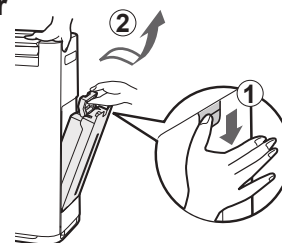

2 Fill the Water Tank with the tap water.

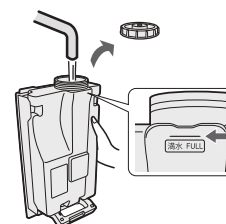

3 To prevent leaks , securely tighten the Tank Cap.

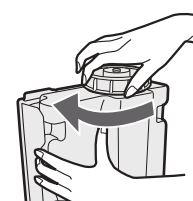

4 Install the Water Tank.

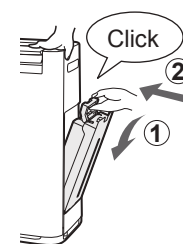

ON



OFF



NOTE

When operating with Humidification ON in the modes in the table below, the unit automatically controls humidity by sensing temperature and humidity. (Except MAX / MED / LOW mode.)

Temperature	Humidity	
	ALL MODE (Except MAX / MED / LOW / SLEEP)	SLEEP MODE
~18 °C	65 %	65 %
18 °C~24 °C	60 %	65 %
24 °C~	55 %	60 %

ON TIMER

Select the length of time you want. The unit automatically starts once the selected time is passes.

(with the unit OFF)

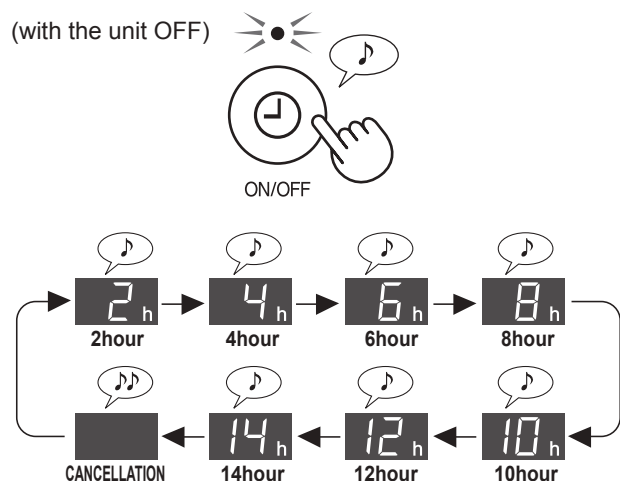

OFF TIMER

Select the length of time you want. The unit automatically stops once the selected time is reached.

(with the unit ON)

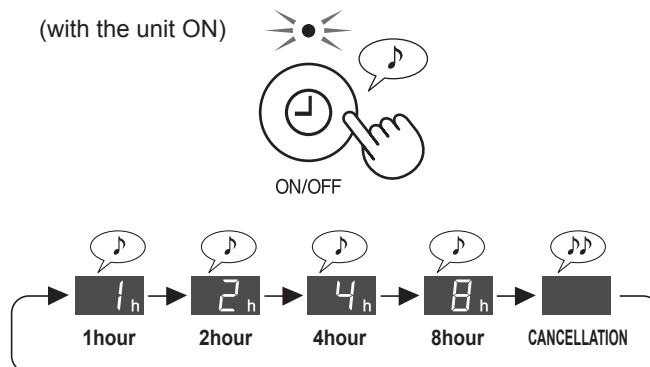

PATROLLING FUNCTION

The sensor detects a state requiring attention to room temperature and humidity during operation and tells it with Patrolling Light. Both "Dry and Low temperature patrolling" and "High temperature and High humidity patrolling" work. (This function informs a room condition. The unit cannot adjust temperature or lower humidity)

DRY AND LOW TEMPERATURE PATROLLING

It tells that the room is dry or the room temperature is low.

When Patrolling Light turns to red, the unit operates with airflow a little stronger during Intelligent mode (Auto mode).

Patrolling Light (●)	If the beeping sound is set to "ON". (Ref. E-12)		Indoor environment	Temperature and humidity area (Figure below)
	Humidity / Temperature Monitor (for 30 seconds)	Beeping sound		
Red	"%" Light turns on	Beep (once)	Dry	(3)
	"°C" Light flashing	Beep (once)	Low temperature	
Green	(Normal)	None	Not dry or low temperature	(1)·(2)

When the room is dry and the room temperature is low, viruses survive more easily. We recommend that you increase humidity with humidification setting and temperature using heating appliances according to your room environment.

Material source: Dr. Makoto Shoji, Director of Shoji internal medicine and pediatrics clinic in Sendai City, Miyagi Prefecture, Japan

Right figure	Absolute humidity* ¹	Virus environment	Survival rate* ²
(1)	Over 11 g	Environment which is less suitable for viruses to survive	0 % to small percent
(2)	11 g or less	Environment where viruses can survive	5 %
(3)	7 g or less	Environment which is suitable for viruses to survive	20 %

*¹ The absolute humidity is the total mass of water vapor present in 1 m³ of air regardless of temperature and is expressed in g. While humidity generally used for a weather forecast is called relative humidity, which is the ratio of the partial pressure of water vapor to the equilibrium vapor pressure of water at a given temperature and is expressed in %. Therefore, the absolute humidity is approximately 8 g at 15 °C and 18 g at 30 °C even at the same relative humidity of 60 %.

*² Survival rate of viruses emitted in air after 6 hours under each environment.

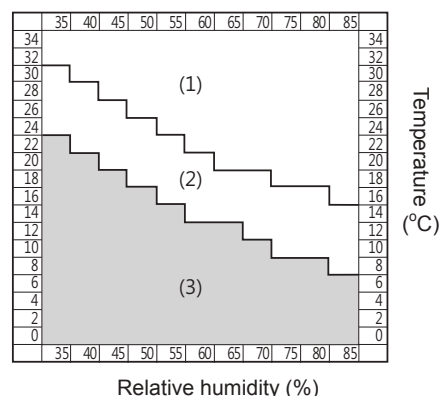

NOTE

- It does not notify of the existence of viruses themselves.
- Patrolling Light's illuminating "Green" does not assure prevention of infection. Use it as a reference to make an environment to prevent infection during typical daily life.
- While adjusting humidity to approximately 55 % to 65 % during operation in Intelligent mode (Auto mode), the unit controls humidification, but does not make changes according to the virus' environment.

SELECTING DISPLAY

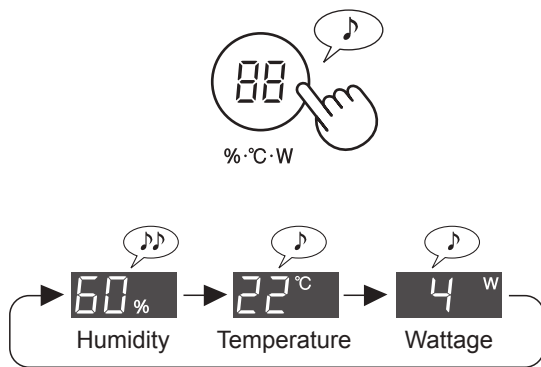

PLASMACLUSTER ION ON/OFF

When the Plasmacluster function is ON, the Plasmacluster Ion light on the Front Display is on. (Ref.E-6)

(with the unit ON)

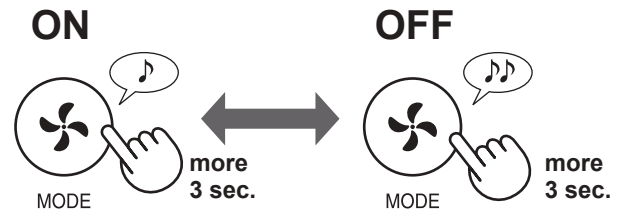

The beeping sound of Patrolling Function is set to "Off" at the default. You can change it to "On" or "Cancel Patrolling Function". (Ref. E-11, E-12)

HIGH TEMPERATURE AND HIGH HUMIDITY PATROLLING

It tells high temperature and high humidity. When Patrolling Light turns to orange or red, the unit stops humidification automatically. (However, it is in MAX/MED/LOW mode, it does not stop humidification)

Patrolling Light (●)	If the beeping sound is set to "ON". (Ref. E-12)		Indoor environment	Temperature and humidity area (Figure below)
	Humidity / Temperature Monitor (for 30 seconds)	Beeping sound		
Red(Flashing)	"°C" Light flashing	Beep · · · (for 30 seconds)	High temperature and high humidity	D
Red	"°C" Light turns on	Beep · · · (for 30 seconds)		C
Orange	"°C" Light turns on	None	Relatively high temperature and high humidity	B
Green	(Normal)	None	Not high temperature nor high humidity	A

We recommend that you drink some water or lower the room temperature.

Guideline for preventing heatstroke in daily life <Source: website of Japanese Society of Biometeorology>

Temperature standard	Overview of life activities to be noted	Precautions
D Danger	Risks that could occur in all life activities	Elderly people are highly likely to suffer from heartstroke even in a resting state. Avoid going out and move to a cooler room.
C Heavy alert		Avoid blazing sun when going out and pay attention to an increase of room temperature when staying in a room.
B Alert	Risks that could occur in middle level or higher life activities	Rest regularly when doing exercise or intense work.
A Caution	Risks that could occur in hard life activities	Generally the risk is low, but people may suffer when doing hard exercise or hard work.

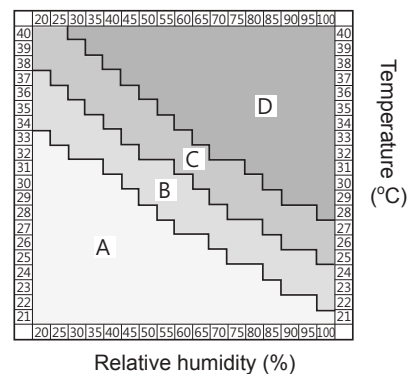

NOTE

This is not a function to prevent heatstroke. Please use this function as an assistance.

HOW TO CHANGE VARIOUS SETTINGS

You can change the functions in the "Type of setting" table in the following.

1 Turn the unit power OFF.



3 Select "Function number" from the table in the following.

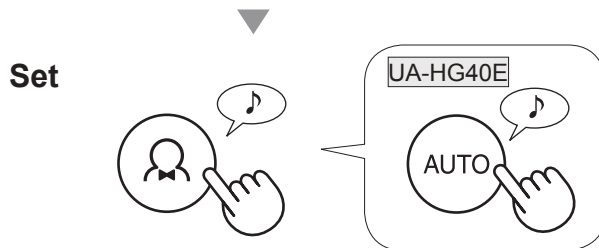
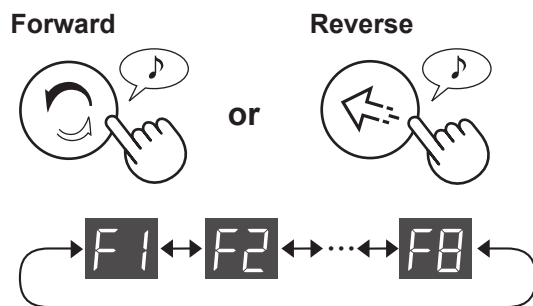

4 Select "Setting number" from the table in the following.

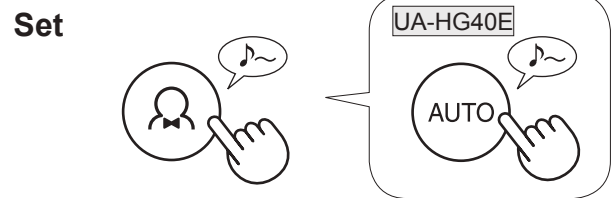
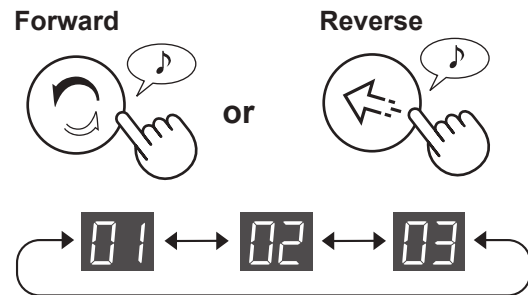

5 Press Power button to finish the setting.



Type of setting

Function	Setting
Light Control You can select the brightness of the Front Display, Cleanliness Monitor and Air Outlet LED.	01 Auto (default) Light automatically switches ON or OFF based on room brightness. Room is bright: light is ON Room is dark: light is OFF
	02 Darker
	03 Turn off <ul style="list-style-type: none"> When set to "Turn off", the "Darker" light illuminates for 3 seconds after operation starts and then the light turns off. The Humidity Light flashes darker only when the unit needs water. Patrolling Light flashes/lights dimmer only when the room temperature or humidity requires attention.

Function	Setting
<p>Sound Indicator Setting You can set the unit to make a beeping sound when the Water Tank is empty.</p> <p style="text-align: right;">F2</p>	<p>01 Cancellation (default)</p> <p>02 ON</p>
<p>Auto Restart If the unit is unplugged or if there is a power failure, the unit will resume operation with the previous settings after power is restored.</p> <p style="text-align: right;">F3</p>	<p>01 Cancellation</p> <p>02 ON (default)</p>
Adjusting Sensor Sensitivity (F4-F7)	
<p>Light Sensor</p> <p style="text-align: right;">F4</p>	<p>01 Low</p>
<p>Dust(sensitive) Sensor</p> <p style="text-align: right;">F5</p>	<p>02 Standard (default)</p>
<p>Odour Sensor (UA-HG60E / UA-HG50E)</p> <p style="text-align: right;">F6</p>	<p>03 High</p>
<p>Motion Sensor (UA-HG60E / UA-HG50E) You can set the time until the Motion Sensor detects that no one is in the room . You can also cancel Motion Sensor sensing.</p> <p style="text-align: right;">F7</p>	<p>01 ON(Standard sensing time) (default)</p> <p>02 ON(Longer sensing time)</p> <p>03 Cancellation</p>
<p>Patrolling Function Setting You can set the unit to make a beeping sound when Patrolling Light turn to red.You can also cancel Patrolling Function.</p> <p style="text-align: right;">F8</p>	<p>01 ON(notifies with Patrolling Light and sound) The beeping sound continues for 30 seconds at maximum. Pressing any button on the operation panel stops the sound. When Patrolling Light is red, the beeping sounds hourly.</p> <p>02 ON(notifies with Patrolling Light only)(default)</p> <p>03 Cancellation</p>

CARE AND MAINTENANCE



FILTER INDICATOR

The filter reset Indicator light will turn on after approximately 720 hours operating. (30 days × 24 hours = 720 hours)

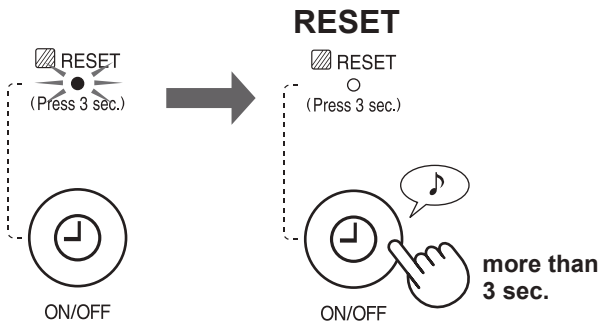

This is a reminder to perform the maintenance described below. After performing maintenance, reset the Filter Indicator.

CARE INDEX

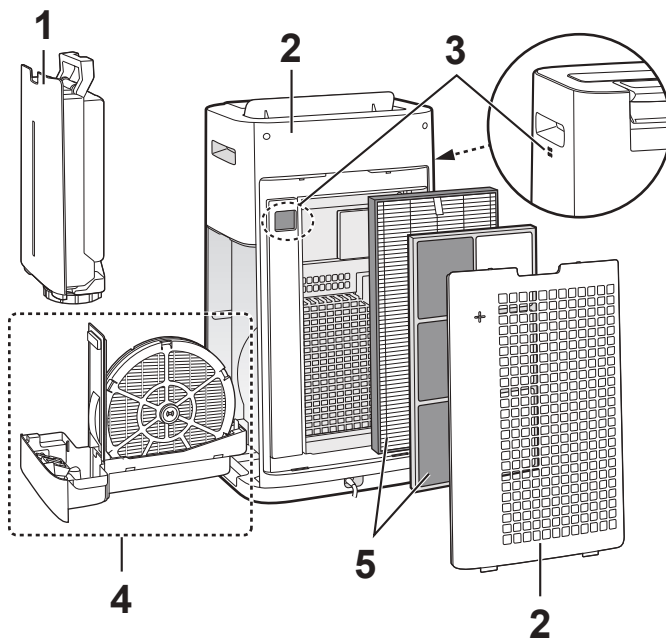

Place		Ref.
1	Water Tank	E-13
2	Unit / Back Panel (Pre Filter)	
3	Sensors	E-14
4	Humidifying Filter Humidifying Tray	
5	HEPA Filter Deodorizing Filter	E-15

WATER TANK



Rinse the inside with water.

NOTE How to clean hard to remove dirt.

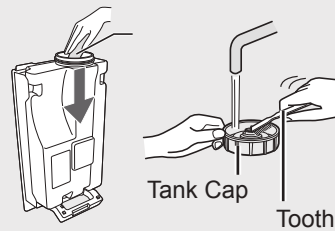

Clean the inside of the Water Tank with a soft sponge and the Tank Cap with a cotton swab or toothbrush.

UNIT / BACK PANEL

Wipe with a dry, soft cloth.

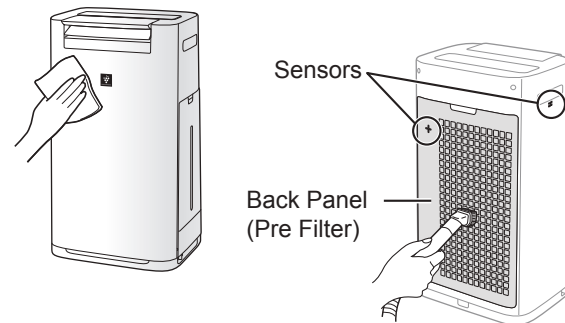

Remove the dust gently with a cleaning tool such as a vacuum cleaner.

NOTE How to clean hard to remove dirt.

Back Panel

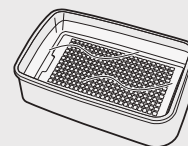

1. Add a small amount of kitchen detergent to water and soak for about 10 minutes.

CAUTION

- Do not apply excessive pressure when scrubbing the back panel.
2. Rinse off the kitchen detergent with clean water.
 3. Completely dry the filter in a well ventilated area.

Sensor Filter

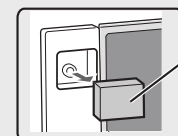

Sensor Filter

1. Remove the Back Panel.
2. Remove the sensor filter.
3. If the sensor filter is very dirty, wash it with water and dry it thoroughly.

HUMIDIFYING FILTER AND TRAY

HOW TO REMOVE THE HUMIDIFYING FILTER AND TRAY.

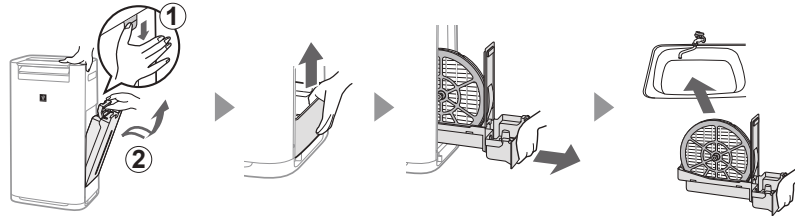

HOW TO ATTACH THE HUMIDIFYING FILTER AND TRAY.

After maintenance, correctly reattach the parts.

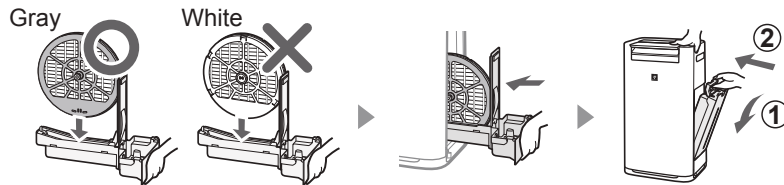

Humidifying Filter

Rinse with plenty of water.

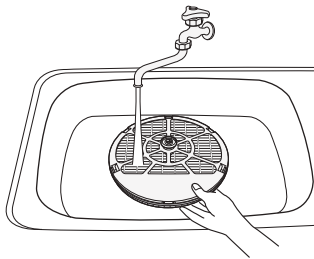

NOTE

If you remove the Humidifying Filter shaft, be sure to reattach it to its original position.

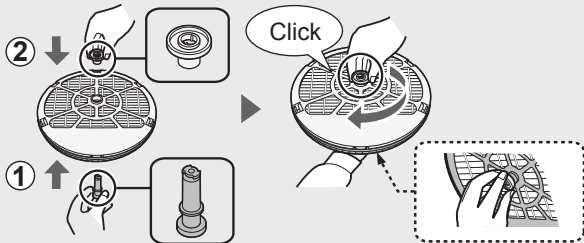

Humidifying Tray

1 Remove the Humidifying Tray Cover.

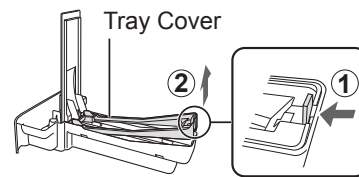

2 Rinse with plenty of water.

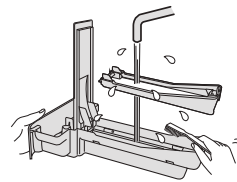

3 Reattach the Humidifying Tray Cover.

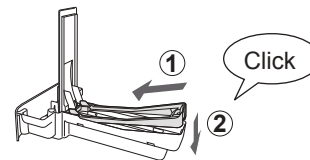

• Do not remove the Float and the Tray Panel. If they come off, refer to E-15.

NOTE How to clean hard to remove dirt.

	Kitchen detergent (only Humidifying tray)	Citric acid (available at some drugstores)	100% bottled lemon juice with no pulp
1	1. Fill the tray half-way with water. 2. Add a small amount of kitchen detergent.	2 1/2 cups of water 3 teaspoons	3 cups of water 1/4 cup
2	Soak for 30 minutes.	Soak for 30 minutes.	Soak for 30 minutes. (When using lemon juice as your descaling solution, allow for more soak time.)
3	Rinse off the kitchen detergent or the descaling solution with clean water.		

HEPA FILTER / DEODORIZING FILTER

Remove the dust on the HEPA Filter and Deodorizing Filter.

CAUTION

- Do not wash the filters. Do not expose to sunlight.

HEPA FILTER

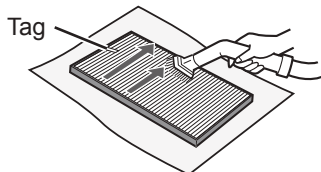

Maintain only the tagged surface. Do not clean up the opposite surface. The filter is fragile, so be careful not to apply too much pressure.

DEODORIZING FILTER

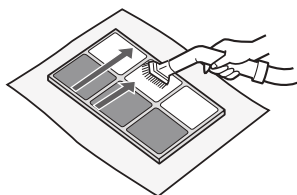

Both surfaces can be maintained. The filter may be broken if being too much power is applied on it, so please handle it with care.

Some odours absorbed by the filters will break down over time, causing additional odours. Depending on usage conditions, and especially if the unit is used in environments significantly more severe than a normal household, these odours may become noticeable sooner than expected.

Replace the filter in those cases or if dust is unable to be removed after maintenance.

How to install the Float and the Tray Panel

Tray Panel

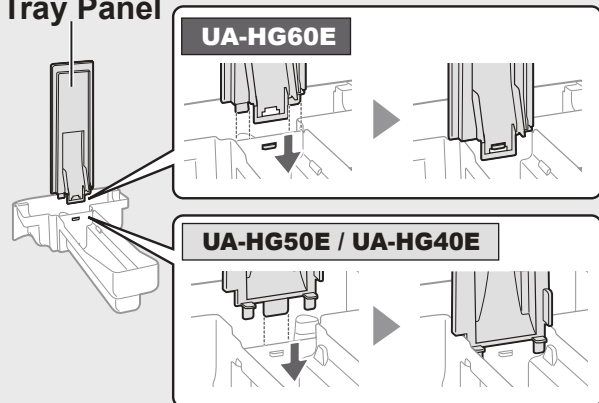

Float

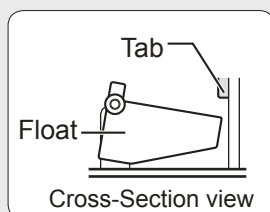

3. Insert the tab on the other side of the float into the hole.

1. Insert the float under this tab.

2. Insert the tab of the float into the hole.

FILTER REPLACEMENT

LIFE OF FILTERS

Filter life varies depending on the room environment, usage conditions, and location of the unit. Lifespan of HEPA filter and Deodorizing filter and replacement suggestions are based on purifying a room in which 5 cigarettes are smoked per day and the unit's dust collection and deodorizing performance has declined to half the level of a new filter.

We recommend replacing the filter more frequently if the unit is used in conditions significantly more severe than a normal household.

- HEPA Filter About 10 years after opening
- Deodorizing Filter About 10 years after opening
- Humidifying Filter About 10 years after opening

Replacement Filter Model

Consult your dealer when purchasing a replacement filter.

Replacement Filter	UA-HG60E	UA-HG50E	UA-HG40E
HEPA Filter (1 unit)	UZ-HD6HF	UZ-HD4HF	UZ-HD4HF
Deodorizing Filter (1 unit)	UZ-HG6DF	UZ-HG4DF	UZ-HG4DF
Humidifying Filter (1 unit)	UZ-HG6MF	UZ-HG6MF	UZ-HG6MF

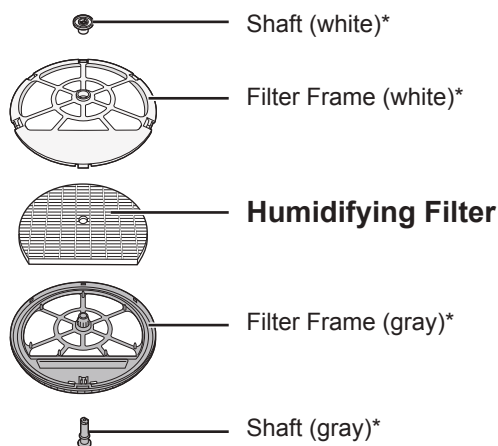

*Do not dispose these parts.

Disposing of filters

Dispose of used filters according to local laws and regulations.

HEPA Filter material:

- Filter: Polypropylene
- Frame: Polyethylene

Deodorizing Filter material:

- Filter: Paper
- Frame: ABS resin

Humidifying Filter material:

- Filter: Rayon, polyester



TROUBLESHOOTING

Before contact for service, review the troubleshooting chart below to make sure that the problem is not a unit malfunction.

SYMPTOM	REMEDY (the following are not due to a malfunction)
Odour and smoke persists.	<ul style="list-style-type: none"> Check the filters. If they appear to be extremely dirty, clean or replace them. (Ref. E-15)
The Cleanliness Monitor is blue even when the air is not clean.	<ul style="list-style-type: none"> The air may have been dirty when the unit was plugged in. Unplug the unit, wait one minute, and then plug the unit in again.
The Cleanliness Monitor light is red even when the air is clean.	<ul style="list-style-type: none"> Dirty or clogged dust(sensitive) sensor openings interfere with sensor operation. Gently clean the sensor filter or the back panel. (Ref. E-13).
The unit makes a clicking or ticking sound.	<ul style="list-style-type: none"> The unit may make clicking or ticking sounds when it is generating ions.
Air discharged from the unit has an odour.	<ul style="list-style-type: none"> Check to see if the filters are extremely dirty. Clean or replace the filters. (Ref. E-13, E-14, E-15) Use only fresh tap water. Using other water sources risks the growth of mold, fungi, or bacteria.
The unit does not operate when cigarette smoke is in the air.	<ul style="list-style-type: none"> Make sure the unit is installed in a location in which the sensors can detect cigarette smoke. Check to see if the dust(sensitive) sensor openings are blocked or clogged. If they are blocked or clogged, clean the sensor filter or the back panel. (Ref. E-13)
The FILTER RESET Indicator Light is on.	<ul style="list-style-type: none"> Whenever after performing maintenance or replacing the filters, connect the power cord to an outlet and then press the Filter Reset Button. (Ref. E-13)
The Front Display is turned off.	<ul style="list-style-type: none"> When Light control is set to "Auto", the light automatically turns off when the room is dark. Moreover, when Light control is set to "Turn off", the light is always off. If you do not want the light to be off, set Light control to the "Darker" setting. (Ref. E-11)
The Humidify Light on the Front Display does not light up when the tank is empty.	<ul style="list-style-type: none"> The room has reached the appropriate level of humidity and has stopped humidifying. Check the styrofoam float for impurities. Clean the Humidifying Tray. Make sure that the unit is on a level surface. (Ref. E-14)
The water level in the tank does not decrease or decreases slowly.	<ul style="list-style-type: none"> Check to see if the Humidifying Tray and Water Tank are correctly installed. Check the Humidifying Filter. (Ref. E-14) If the filter is extremely dirty, clean or replace it. (Ref. E-15)
The Cleanliness Monitor changes colour frequently.	<ul style="list-style-type: none"> The Cleanliness Monitor automatically changes colour when the dust (sensitive) sensor and odour sensor* detect impurities. If you are concerned about the change, you can change sensor sensitivity. (Ref. E-11,E-12) (*UA-HG60E / UA-HG50E)
There is a discrepancy between the unit's Humidity Monitor and another hygrometer in the room.	<ul style="list-style-type: none"> There is a difference in the humidity level within the same room. The sensor have different measurement parameters. If the monitor indicates wattage or temperature, switch the display by pressing the DISPLAY SELECT button. (Ref. E-10)
The unit PM2.5 Light does not match weather report or other local PM2.5 data.	<ul style="list-style-type: none"> Outdoor and indoor as well as the home environment (the volume of traffic nearby, number of stories in home, etc.) may cause a reading different than local PM2.5 data.
"°C" Light flashing	<ul style="list-style-type: none"> The room is suitable for viruses to survive due to low room temperature. We recommend you adjust the temperature using heating appliances. (Ref. E-9) The room temperature and humidity is high. We recommend that you drink some water or lower the room temperature. (Ref. E-10)

ERROR DISPLAY

If error occurs repeatedly, contact the Sharp Service Centre.

DIGITAL INDICATION	REMEDY
	Make sure that the Humidifying Filter and Humidifying Tray are properly installed, and then turn the power to ON again.
	Unplug the unit, wait one minute, and then plug the unit in again.

SPECIFICATIONS

Model		UA-HG60E			UA-HG50E			UA-HG40E		
Power supply		220-240 V 50-60 Hz								
Fan Speed Adjustment		MAX	MED	LOW	MAX	MED	LOW	MAX	MED	LOW
CLEAN AIR	Fan Speed (m ³ /hour)	408	240	72	306	180	60	240	120	60
	Rated Power (W)	72	38	5.0	53	26	5.0	31	12	5.0
	Noise Level (dBA)	53	48	24	52	47	19	46	40	19
CLEAN AIR & HUMIDIFY	Fan Speed (m ³ /hour)	342	240	72	240	120	60	210	120	60
	Rated Power (W)	55	40	6.5	33	14	6.5	24	14	6.5
	Noise Level (dBA)	49	48	24	46	40	20	43	40	20
	Humidification (mL/hour) *1	630	470	200	450	300	150	400	300	150
Recommended Room Size (m ²) *2		~50			~38			~28		
High density Plasmacluster ion recommended room size (m ²) *3		~35			~28			~21		
Water Tank Capacity (L)		3.0			2.5			2.5		
Sensors		Dust(sensitive) / Odour / Light / Temperature & Humidity / Motion						Dust(sensitive) / Light / Temperature & Humidity		
Cord Length (m)		2.0								
Dimensions (mm)		370 (W) × 293 (D) × 660 (H)			345 (W) × 262 (D) × 631 (H)			345 (W) × 262 (D) × 631 (H)		
Weight (kg)		10.5			9.2			9.2		

- *1 • The amount of humidification changes in accordance with indoor and outdoor temperature and humidity. The amount of humidification increases as temperatures rises or humidity decreases. The amount of humidification decreases as temperatures decrease or humidity rises.
• Measurement Conditions: 20 °C, 30 % humidity (JEM1426)
- *2 • The recommended room size is appropriate for operating the unit of maximum fan speed.
• The recommended room size is an area in which a given amount of dust particles can be removed in 30 minutes.
- *3 • Room size in which approximately 7000 ions per cubic centimeter can be measured in the centre of the room when the unit is placed next to a wall, is running at MED mode settings, and is at a height of approximately 1.2 meters from the floor.

Standby Power

When the unit's power plug is inserted in a wall outlet it consumes about 1.2 watts of standby power in order to operate electrical circuits.

To conserve energy, unplug the power cord when the unit is not in use.