

BLUETTI EB55

User Manual

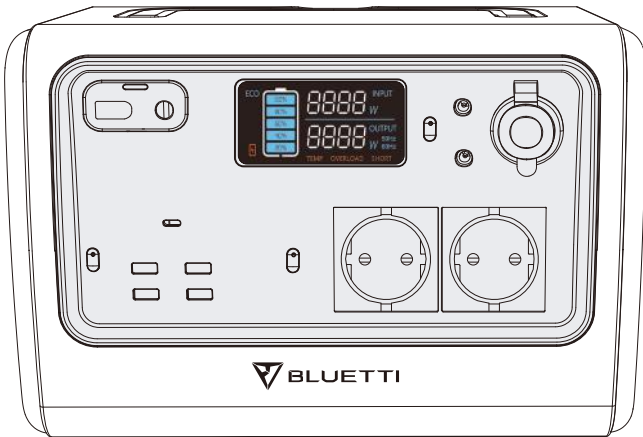

Thank You

Thank you for making BLUETTI a part of your family.

From the very beginning, BLUETTI has tried to stay true to a sustainable future through green energy storage solutions for both indoor and outdoor use while delivering an exceptional eco-friendly experience for our homes and our world.

That's why BLUETTI makes its presence in 70+ countries and is trusted by millions of customers across the globe.



Before You Begin

The information contained herein is subject to change without notice.

For the latest version, please visit <https://www.bluettipower.eu/pages/manuals>.

- The user manual contains instructions and notes on the operation and use of this unit.
- BLUETTI recommends that you use genuine accessories from BLUETTI.
- BLUETTI shall not be responsible for any damage or expense that might result from the use of parts other than genuine parts from the BLUETTI.
- For your safety and benefit, please read carefully before using and keep it handy for future reference.

Important Safety Instructions

BLUETTI products are developed to be safe and reliable. Please read this guide for important safety information about your device. The guide is intended to help you be more comfortable and productive while using this device. Failure to follow these guidelines for proper set up, use, and care for your device may cause damage to this unit and injury to yourself or others.

SAVE THESE INSTRUCTIONS!

- Always operate or store the unit in accordance with specified temperature range.
- DO NOT expose the unit to fire, liquids, sweat, dirt or other contaminants, as that may cause the battery to explode or leak flammable liquid or gas.
- DO NOT place the unit on an unstable or tilted surface.
- Make sure the place where you are using the unit is well ventilated and spacious.
- Keep away from children and pets.
- DO NOT modify, attempt to insert foreign objects into the battery, or immerse or expose it to water or other liquids. Batteries may explode if damaged.
- Battery fluid is corrosive and may be toxic. If a battery leaks, keep the leaked fluid from touching your skin, eyes, clothes, or other surfaces. Immediately flush the affected areas with water, or seek medical help.
- DO NOT ignore those warning signs on components or products made by manufacturers.
- DO NOT dismantle, cut, crush, puncture, or otherwise damage the unit in any way.
- DO NOT insert foreign objects into the fan, vents, ports, or other openings.

- NEVER use a damaged battery or component. Improper use or misuse of damaged batteries may cause damage your device or injury to yourself as a result of battery fluid leakage, fire, overheating, or explosion.
- Use approved battery and accessories ONLY. Improper use, or use of unapproved or incompatible batteries or components may result in a risk of fire, explosion, or other hazard, and may invalidate any approval or warranty.
- Turn off the unit IMMEDIATELY in case of malfunction.
- Use dry powder fire extinguisher in case of fire.
- DO NOT attempt to modify, replace the internal battery or any other component of the unit by anyone other than qualified personnel. If necessary, take it to an authorized service center as incorrect reassembly may result in a risk of fire or electric shock.

SAVE THESE INSTRUCTIONS!

Maintenance Instructions

- When not using the unit for extended periods of time, power off the unit and disconnect the AC adapter from the outlet.
- Charge the unit to 80% SOC every 3-6 months for long-term storage.
- Clean the unit with a dry cloth gently and carefully.

Handling and Storage Instructions

- Use mechanical assistance as needed (e.g. trolleys and adjustable height workbenches).
- DO NOT stack anything on top of the unit either in storage or in use.
- Recommended storage temperature: 14-113°F/-10-45 C.

What's In The Box

Standard Packaging

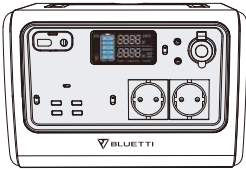

Portable Power Station



Warranty Card

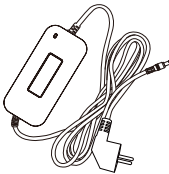

AC Adapter



User Manual

* Below accessories are not included in standard packaging and can be purchased separately at <https://www.bluettipower.eu>.



Car Charging Cable

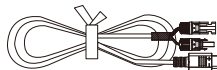

Solar Charging Cable

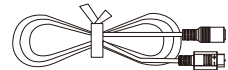

DC7909-XT60 Female Cable

* **AC Adapter:** 47in/120cm.

Car Charging Cable: 28in/72cm. XT60 to Cigarette lighter port.

Solar Charging Cable: 59in/150cm. XT60 to MC4.

DC7909-XT60 Female Cable: 20in/50cm. DC7909 to XT60.

Note: Package details are subject to change without prior notice.

Product Overview

Diagram

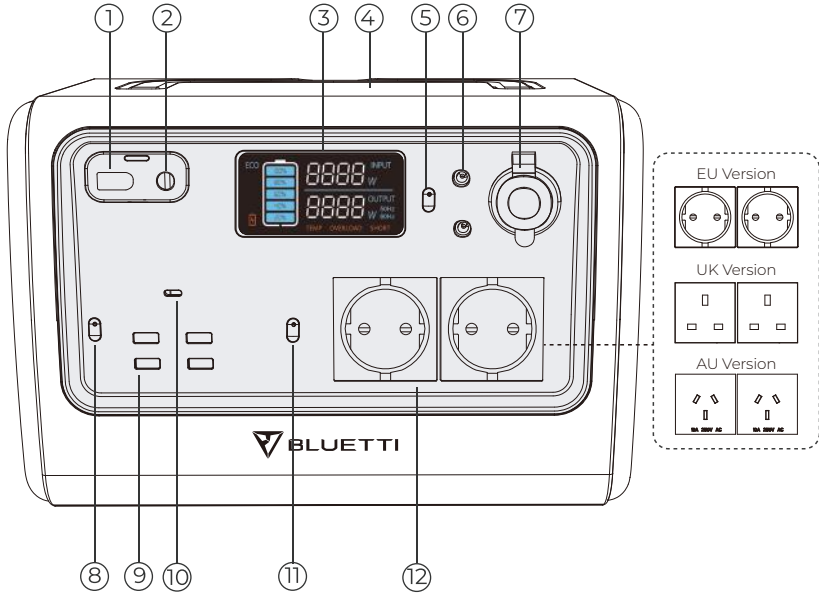

- | | |
|--------------------------|---------------------------|
| 1. DC Input | 7. Cigarette Lighter Port |
| 2. Adapter Input | 8. DC Power Button |
| 3. LCD Screen | 9. USB-A Port |
| 4. Wireless Charging Pad | 10. USB-C Port |
| 5. DC 12V Power Button | 11. AC Power Button |
| 6. DC5521 Port | 12. AC Output |

Specifications

EB55		
General		
Battery Capacity	537Wh	
Cell Type	LiFePO4	
Dimensions (L*W*H)	10.94*7.87*7.79IN/278*200*198MM	
Weight	16.5LB/7.5KG	
Discharging Temperature	-4-104°F/-20-40°C	
Charging Temperature	32-104°F/0-40°C	
Storage temperature	-20-45°C(Optimal: 20-30°C)/-4-113°F(Optimal: 68-86°F)	
Working Humidity	10-90%	
AC Output		
Power	700W	
Surge	1400W	
Voltage(EU/UK/AU)	220-240VAC	
DC Output		
Cigarette Lighter Port *1	Voltage	12VDC
	Current	10A (Cigarette Lighter and DC5521 10A total)
DC5521 *2	Voltage	12VDC
	Current	10A total (Cigarette Lighter and DC5521 10A total)
USB-A *4	Voltage	5VDC
	Current	3A
USB-C PD3.0 *1	Power	100W Max.
Wireless Charging *1	Power	5/7.5/10/15W
Adapter Input		
Power	200W Max.	
Voltage	25-28VDC	
Current	10A Max.	
PV Input		
Power	200W Max.	
Open Circuit Voltage (OCV)	12-28VDC	
Current	8A Max.	
Car Charging	98W@12V; 196W@24V	
Adapter + PV Dual Charging	400W Max. (200W for Both Adapter and PV)	
Dual Adapter Charging	400W Max. (Extra adapter needed)	

Operation

LCD Screen

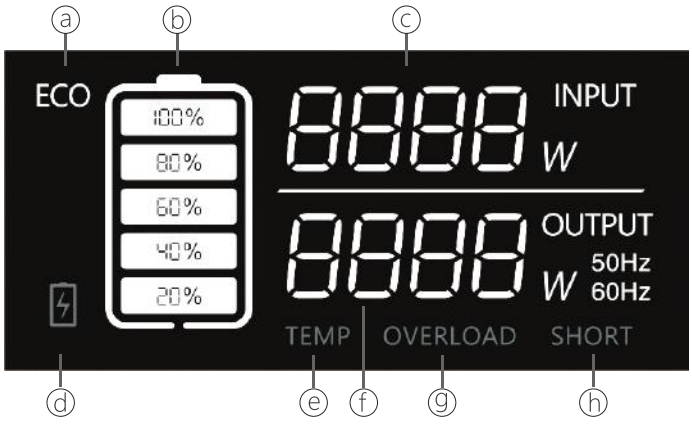

a: ECO Mode

b: Battery Capacity

c: Input Power

d: Low-battery Alert

e: Temperature Anomaly Alert

f: Output Power

g: Overload Alert

h: Short-circuit Alert

Powering On/Off

Powering on: Press the AC/DC/DC 12V Power Button to start up corresponding output.

Green light(on the button)	ON
LCD Display	ON*

*The LCD screen is on for 30-60 seconds. Please enable at least one of these ports (AC/DC/DC 12V) if you want the display to stay on longer.

Note: Please turn on the DC power to enable the wireless charging.

Powering off: Press and hold power buttons to shut down corresponding output.

Green light(on the button)	OFF
LCD Display	OFF

Mode

Setting Mode: When the AC output is off, press AC and DC power buttons simultaneously and the frequency indicator flashes.

ECO Mode¹: Under 'Setting Mode', press the DC power button to turn it on/off.

Setting

AC Frequency²: Under 'Setting Mode', press the AC power button to switch.

Charging

AC Charging

Simply plug the EB55 into a standard wall outlet and start charging.

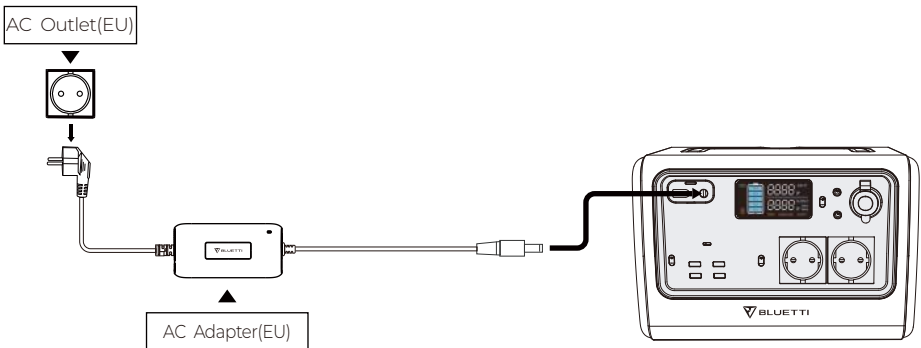

¹When on this mode, the AC/DC output will automatically turn off after 4-hour low ($\leq 10W$ for AC, $\leq 1W$ for DC) or no load to save power.

²AC Frequency: The number of alternating cycles per second in an AC sine wave. The utility frequency is usually 50/60Hz.

PV Charging

Connect the solar panels (in series or parallel) to EB55 via the solar charging cable.

Note: Please make sure your solar panels comply with:

OCV³: 12-28V Input Current: 8A Max. Input Power: 200W Max.

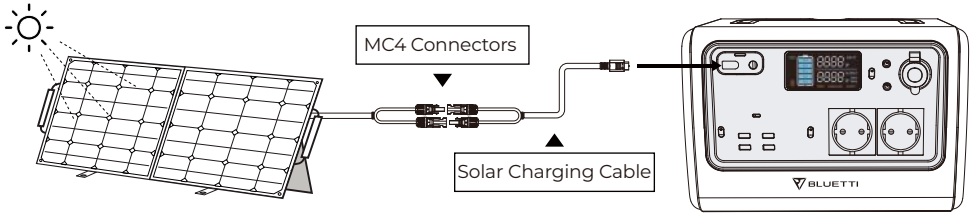

Car Charging

Connect the EB55 directly to the vehicle plug-in cigarette lighter port via the car charging cable.

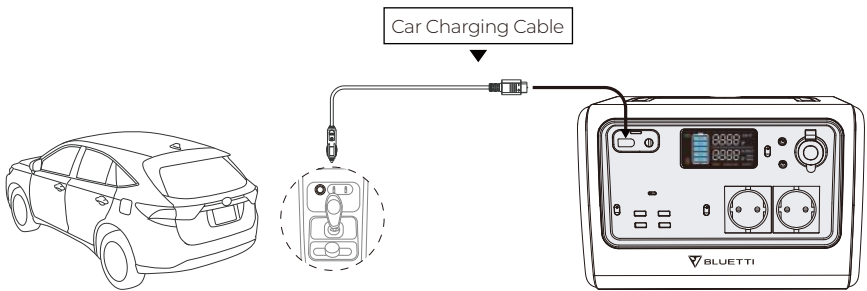

³OCV: Open circuit voltage. The maximum voltage that the solar panel can produce with no load on it.

Generator Charging

Connect the AC adapter input plug to the generator while the output plug goes to the DC charging port of EB55.

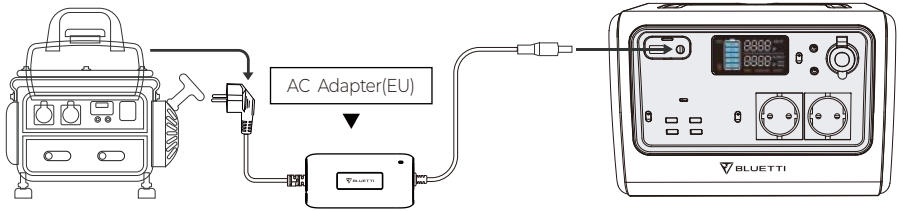

Dual Charging

EB55 also supports dual charging. (e.g. Adapter+ PV Charging and Dual Adapter Charging).

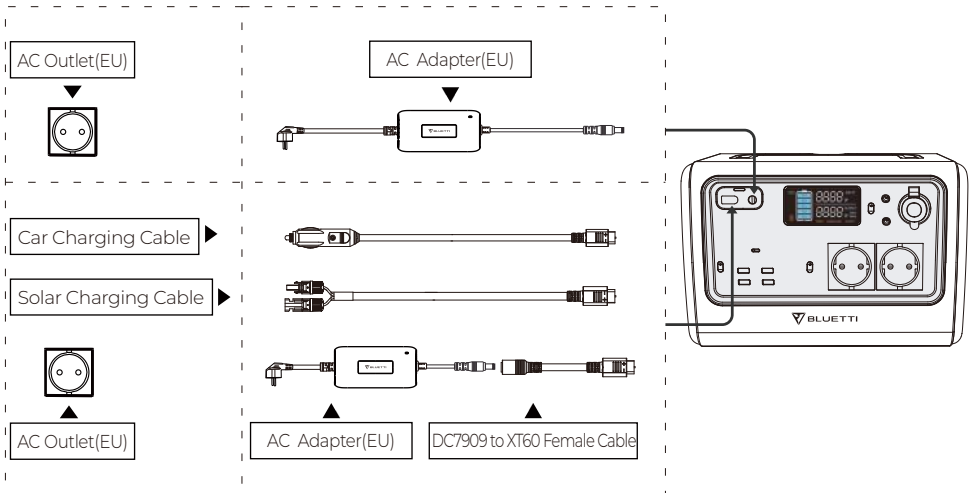

⁴An extra adapter (200W AC Adapter + DC7909-XT60 Female Cable) is needed for Dual Adapter Charging.

Discharging



Phone
40-50 Times
10Wh



LED Light
20-30Hrs
20W



Television
5-6Hrs
75W



Electric Tool
5-6Hrs
80W



Refrigerator
4-5Hrs
90W



Slow Cooker
2-3Hrs
200W

$537\text{Wh} \times \text{DoD} \times \eta \div (\text{load power}) = \text{charging time (estimated)}$

Note: DoD refers to the Depth of Discharge, η is the local inverter efficiency. DoD=90%, η =90%.

Load power and charging time are measured in Watt and Hour.

Appendix

FAQs (Frequently Asked Questions)

Q: How do I know whether my devices will work well with this product?

A: Please evaluate the total constant load of your appliances. If it doesn't exceed the Max. output power of EB55, you can use this power station to charge.

Q: Can I use third-party solar panels to charge this product?

A: Yes, you can. As long as the specs of solar panels you're using fall in below range:

OCV: 12-28V

Input Current: 8A Max.

Input Power: 200W Max.

With the same power connector (MC4 or Anderson)

Q: How can I charge this EB55 by dual adapter charging?

A: An extra adapter (200W AC Adapter + DC7909-XT60 Female Cable) is needed to connect to the DC input port.

Q: Is there a button to turn on/off the wireless charging?

A: Yes. Press the DC Power Button to enable the wireless charging.

Q: Can it charge and discharge at the same time?

A: Yes. It supports pass-through charging. EB55 comes with the premium LiFePO4 battery and proprietary Battery Management System to ensure that it can charge and discharge at the same time.

Technical Support

Should you require any further assistance, please do not hesitate to contact BLUETTI service team.

BLUETTI POWER INC

Mail: sale-eu@bluettipower.com

Add: LindwurmstraBe 114, 80337 Munich, Germany.



Manufacturer:	
Company name:	Shenzhen PowerOak Newener Co.,ltd
Address:	F19, BLD No.1, Kaidaer, Tongsha Rd No.168, Xili Street, Nanshan, Shenzhen, China
Company registration No.:	91440300071761480R
VAT No.:	
Tel:	0086-755-23705980
E-Mail:	feedback@poweroak.net

EU Kontakt:	
Company name:	Shenzhen PowerOak Newener Co.,ltd
Address:	Lindwurmstr. 114, 80337 Munich, Germany
Company registration No.:	HRB 261852
VAT No.:	DE342113007
Tel:	0049 421 87852946
E-Mail:	logi@bluetti.de

UK Kontakt:	
Company name:	POWEROAK ENERGY UK CO., LTD
Address:	Unit 2 Northgate, Bolsover Busines Park, Bolsover, S44 6BD
Company registration No.:	396829822
VAT No.:	
Tel:	0044-7860 8449 32
E-Mail:	poweroak.eu@bluetti.com

