

Humidifying air purifier Nemlendirici hava filtresi

Floor standing type
Zemine monte tip

Models / Modeller

MCK70ZVM-W
MCK70ZVM-H

- The [SSID] and [KEY] printed on the SSID/KEY sticker are required when connecting the humidifying air purifier and smartphone via wireless LAN. (►Page 8)
- [SSID] and [KEY] are different for each product, so keep the SSID and KEY in a safe place with the production no. For the production no., please check the back of the product. (►Page 8)
- SSID/KEY çıkartmasında basılı [SSID] ve [KEY] bilgileri kablosuz LAN üzerinden nemlendirici hava filtresi ile akıllı telefonu bağlarken gereklidir. (►Sayfa 8)
- [SSID] ve [KEY] bilgileri her ürün için farklıdır, bu nedenle SSID ve KEY bilgilerini üretim numarası ile birlikte güvenli bir yerde saklayın. Üretim numarası için lütfen ürünün arkasına bakın. (►Sayfa 8)

SSID/KEY entry field
SSID/KEY giriş alanı

Production no. entry field
Üretim numarası giriş alanı

Humidifying Air Purifier OPERATION MANUAL KULLANIM KILAVUZU



- Thank you for purchasing this humidifying air purifier.
- Please read the operation manual carefully and follow it for correct use.
- **Please read the “Safety Precautions” section before use.** (►Page 2-6)
Please keep the operation manual in a safe place for later reference.
- Bu nemlendirici hava filtresini satın aldığınız için teşekkür ederiz.
- Lütfen kullanım kılavuzunu dikkatli bir şekilde okuyun ve doğru kullanım için kılavuza uyun.
- **Kullanmadan önce lütfen “Güvenlik Önlemleri” bölümünü okuyun.** (►Sayfa 2-6)
Lütfen kullanım kılavuzunu daha sonra başvurmak üzere güvenli bir yerde saklayın.

Contents

Read First



Safety Precautions	2
Precautions During Use	7
Names of Parts and Operations	8
Preparation Before Operation	13
Attaching the deodorising filter	14
Operating the air purifier via smartphone	18

Operation

AUTO Operation	21
Air Purifying Operation	22
Changing the Airflow Rate	22
Humidifying and Air Purifying Operation	23
About Humidifying Filter Drying Operation	24
Operating MODEs	24
AUTO FAN / ECONO / ANTI-POLLEN / MOIST / CIRCULATOR	

Advanced Settings

Streamer Output Setting	27
Active Plasma Ion Output Setting	29
PM2.5 sensor Sensitivity Setting	29
Monitoring mode within AUTO Operation and ECONO MODE ...	31
Airflow rate range for AUTO FAN	31
Humidifying Filter Drying Operation	33
Airflow rate limit when the water supply lamp is lit	33
Notification tone when water supply lamp is lit	33

Maintenance

Maintenance Quick Reference Table	35
When Not Using the Unit for a Prolonged Period	44



Troubleshooting

FAQs	45
States of the AIR MONITOR indicator and Their Meanings ...	47
Troubleshooting	48
Specifications	55
Separately Sold Parts	56

The images in this manual are for illustrative purposes only.
 The English text is the original instruction.
 Other languages are translations of the original instructions.

Safety Precautions

- Observe these precautions in order to prevent property damage or injury.
- The consequences of incorrect use are categorized as follows:

 WARNING	 CAUTION
Failure to follow these instructions properly may result in personal injury or loss of life.	Failure to follow these instructions properly may result in property damage or personal injury, which may be serious depending on the circumstances.

- Precautions to be observed are categorized using symbols:

 Never attempt.	 Be sure to follow the instructions.
---	---

 **WARNING** Observe in order to prevent fire, electric shock or severe injury.

- Concerning the power supply plug and cord

-  • **Do not unplug while the unit is in operation.**
(Fire due to overheating or electric shock may result)
- **Do not plug in or unplug with wet hands.**
(An electric shock may result)
- **Do not use in such a way that the ratings of the power socket or wiring appliances are exceeded or use a voltage outside of the range AC220-240V.**
(Fire may result from overheating if the ratings of multi-socket power adapters, etc., are exceeded)
- **Do not pull on the power supply cord when unplugging.**
(Overheating or fire may result from wire breakage)
- **Do not perform actions that might break the power supply plug and cord.**
–Such actions including damaging, modifying, forcibly bending, pulling, twisting, bundling up, placing heavy objects on the power supply plug or cord.
If the power supply plug or cord is damaged, please contact the place of purchase.
(An electric shock, short circuiting or fire may result from use while damaged)

-  • **Insert the power supply plug firmly all the way in.**
–Do not use a damaged power supply plug or a loosely fitted power socket.
(Electric shock, short circuiting or fire due to overheating may result if the power supply plug is not firmly inserted)
- **Periodically wipe dust off the power supply plug with a dry cloth.**
–If the unit is not to be used for a prolonged period, unplug the power supply.
(Fire may be caused by defective insulation resulting from dust buildup with moisture, etc.)
- **When performing maintenance, inspecting, moving the unit, or refilling the water tank, be sure to turn off and unplug the unit.**
(An electric shock or injury may result)



- Unit

-  • **Do not use flammable sprays (hair spray, insecticides, disinfectants, air dusters, etc.) or deodorisers on the unit.**
(Do not use such articles where there is a risk of suction into the unit)
Do not wipe the unit with benzine or thinner.
(Fire, deformation of the unit, cracking or other faults may result)

Safety Precautions

 **WARNING** Observe in order to prevent fire, electric shock or severe injury.

■ Do not use in the following places

-  • **Places where oil or flammable gases are used or may leak.** (Fire or smoke may result from ignition or suction toward the unit, or injury may result from degradation or cracking of plastic)
- **Places where there are corrosive gases or metal dust particles.** (Fire or smoke may result from ignition or suction toward the unit)
- **Places where temperature and humidity levels are high or water may splash, such as a bathroom.** (Fire or an electric shock may result from electrical leakage)
- **Places accessible to small children or animals without supervision.** (An electric shock or injury may result. Further concerning of a RF Exposure, See the  Page 5 for details)
- **Places where the floor is unstable.** (Household items etc., may get wet, or a fire or an electric shock may result if the unit falls over)

■ During use

-  • **Do not use chlorinated or acidic detergents.** (Harm may be caused to health from the production of toxic gases, or injury may result from degradation or cracking of plastic)
- **Keep burning cigarettes or incense sticks away from the unit.** (Fire or smoke may result from ignition or suction toward the unit)
- **Do not attempt to disassemble, reconstruct or repair the unit yourself.** (Fire, an electric shock or injury may result) For repairs, please contact the place of purchase.
- **Do not insert fingers, sticks, or any other item, into the air inlets or air outlet.** (An electric shock, injury or damage may result)
- **Do not pour water onto the air outlet or the unit.** (Fire or an electric shock may result)
- **Do not use petrol, benzene, thinner, polishing powder, paraffin, alcohol, etc.** (Cracking, electric shock, and ignition of fire may result)
- **Do not use flammable sprays (hair spray, insecticides, disinfectants, air dusters, etc.) or deodorisers near or directly on the unit.** (Do not use such articles where there is a risk of suction into the unit)
- **Do not wipe the unit with benzene or thinner.** (Fire, deformation of the unit, cracking or other faults may result)
- **Do not wash the unit with water.** (An electric shock and fire or malfunctioning may result)
- **If the air purifier is located in a place which may be used by people with cardiac pacemakers, do not turn on the wireless LAN connection adapter with the communication ON/OFF button.** (It may affect the operation of pacemakers or other devices, causing trouble)
- **Do not turn on the wireless LAN connection adapter near people with cardiac pacemakers or defibrillators.** (If it is too close, radio waves may affect the operation of the pacemaker or other devices)
- **Do not turn on the wireless LAN connection adapter near automatic control devices such as automatic doors.** (Accidents may result due to device malfunction)

⚠ WARNING Observe in order to prevent fire, electric shock or severe injury.

When operating the air purifier from outside the home, it is not possible to check the condition of the air purifier, its surroundings, people in the room, etc., so be sure to adequately check the safety in advance before using it.

Depending on the circumstances, people may be killed or seriously injured, or property damage may result.

■ Check the following in advance (while at home)

- !** • **Make sure that the power supply plug is firmly inserted all the way to the base. There should be no dust buildup on the power supply plug.**
(Heating, ignition, and fire may result due to poor contact and defective insulation)
- **Make sure that there are no existing schedule timer reservations set by another person.**
(May cause poor physical condition due to unexpected start or stop of operation. May cause adverse effects to plants and animals. Use of this air purifier does not “guarantee” room humidity)
- **Make sure there are no problems with the air purifier. Make sure that changes in airflow will not adversely affect people in the room.**
(Make sure there are no objects that can fly away)
(Airflow may cause objects to fall, resulting in fire, injury or stains on household items)

■ Check the following before and while operating the air purifier from outside the home

- !** • **If you know that there are people at home, let them know that you will start or stop operation remotely.**
(If someone is at home standing on a stool or ladder, they may be surprised at the sudden start or stop of operation, and may fall off the stool or ladder. Also, bad physical condition may be caused by sudden changes in the indoor environment)
–Operation of the air purifier can be started and stopped by pressing the buttons on the air purifier itself, even when it is being operated from outside the home.
–Do not operate the air purifier remotely if there are people in the room who cannot operate it by themselves, such as small children, people with disabilities, elderly people, etc.
- **Frequently check the settings and operating conditions.**
Bad physical condition and adverse effects to plants and animals may be caused by sudden changes in the indoor environment.
If an error occurs with the air purifier, stop operation immediately and contact the place of purchase.
Check again via the operation screen to make sure that operation is stopped.

■ Immediately turn off and unplug the unit if there are any signs of abnormality and malfunction

- !** **Examples of abnormality and malfunction**

 - The unit does not operate even if the switch is turned on.
 - Current passes through the cord or fails to pass through if the cord is moved.
 - There are abnormal sounds or vibrations during operation.
 - The casing of the unit has become deformed or is abnormally hot.
 - There is a burnt smell. (Malfunction, an electric shock, smoke, fire, etc., may result if the abnormality is not addressed and the unit continues to be used)
Contact the place of purchase.

Safety Precautions

 **CAUTION** Observe in order to prevent electrical leakage, injury or property damage.

This product should be operated in the following environment.

(Malfunctioning may result)

Air Purifying Operation: 1 to 40°C

Humidifying and Air Purifying Operation: 1 to 35°C

■ During use

- 
 - **Small children or immobile persons (due to illness or injury) should not operate the unit by themselves.**
 - ◆ For EU, UK, Turkey:

This appliance can be used by children aged from 8 years and above and persons with reduced physical, sensory or mental capabilities or lack of experience and knowledge if they have been given supervision or instruction concerning use of the appliance in a safe way and understand the hazards involved.
Children shall not play with the appliance. Cleaning and user maintenance shall not be made by children without supervision.
 - ◆ For other regions:

This appliance is not intended for use by persons (including children) with reduced physical, sensory or mental capabilities, or lack of experience and knowledge, unless they have been given supervision or instruction concerning use of the appliance by a person responsible for their safety.

 - Children should be supervised to ensure that they do not play with the appliance.
 - Persons who are heavily intoxicated or have taken sleep medication should not operate the unit.
(An electric shock, injury or poor health may result)
 - **Do not drink the water from the water tank. Do not give the water to animals or plants.**
(Harm may be caused to the animal or plant)
 - **Do not use combustion-based heating devices in places directly exposed to airflow from the air outlet.**
(Carbon monoxide poisoning due to incomplete combustion of the combustion-based heating device may result)
 - **Do not use products that contain fine powder, such as cosmetics, near the unit.**
(An electric shock or malfunction may result)
 - **Do not operate the unit when fumigating insecticide is in use.**
 - After using insecticide, be sure to sufficiently ventilate the room before operating the unit.
(Harm may be caused to health from an outflow of accumulated chemical compounds from the outlet)
 - **Do not use the unit near a smoke detector.**
 - If the air coming out of the unit flows in the direction of the smoke detector, the response of the smoke detector may be delayed or it may fail to detect smoke.
 - **Do not operate with the water tank removed.**
 - Please check that the lid of the water tank and the packing is attached correctly. (Water leakage or injury may result)
 - **Concerning of RF Exposure (Council Recommendation, 1999/519/EC)**
 - This unit contains a radio transmitter and a radiation source.
For health protection from a non-ionising radiation of the unit, the minimum separation distance between the unit and the user must be maintained at 30cm.

⚠ CAUTION Observe in order to prevent electrical leakage, injury or property damage.

- !** • **Frequently ventilate the room when using the unit together with combustion-based heating devices.**
 –Usage of this product is not a substitute for ventilation. (Potential cause of carbon monoxide poisoning)
 This product cannot eliminate carbon monoxide.
- **If the unit is placed within reach of a pet, be careful that the pet does not urinate on the unit or chew on the power supply cord.**
 (Fire, an electric shock or injury may result)
- **When using the humidifier, maintain the cleanliness of the water tank, humidifying tray, and humidifying filter unit at all times.**
 –Replace the water in the water tank with fresh tap water everyday.
 –Discard any water remaining in the humidifying tray everyday.
 –Periodically perform maintenance on internal components (humidifying tray, humidifying filter unit).
 (Harm may be caused to health from the propagation of mould or bacteria in dirt and water scales)
 Consult a medical professional if you experience any health abnormalities.
- **Once a day, fill the water tank with water. Check that there is no water leaking from the bottom of the tank due to dirt trapped in or around the valve.**
 (If water leaks, household items may get wet, and electric shock and electrical leakage may result)
- **Before attaching the casters, make sure to unplug the unit and discard any water in the water tank and humidifying tray.**
 (Malfunctioning may result)

■ Concerning the unit body

- ⊘** • **Do not block the air inlets or air outlet with laundry, cloth, curtains, etc.**
 (Overheating or fire may result from poor circulation)
- **Do not apply deodorising spray or other types of spray to the unit, or use near the unit.**
 (Malfunction may result)
- **Do not climb, sit or lean on the unit.**
 (Injury may result from falling or toppling)
- **Do not lay the unit horizontally or tilt the unit.**
 (An electric shock or malfunction may result from water leaking or spilling)

■ When moving the unit

- !** • **Before moving the unit, turn off the power, and discard any water in the water tank and humidifying tray.**
 (Household items etc., may get wet, or an electric shock or electrical leakage may result from water leaking or spilling)
- **When picking up the unit to move it, handle the unit with caution.**
 –Be sure to always hold the unit using the correct grip locations.
 Do not hold the unit using the grip on the water tank or humidifying tray. (Injury may result from the unit falling)

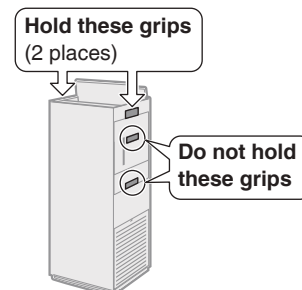

CKO004EU

Precautions During Use

Other considerations

- **Do not use this product for special purposes such as in the preservation of works of art, academic texts/materials, etc.**
(Degradation of preserved items may result)
- **Do not excessively humidify the air.**
(Condensation and mould growth may result)
- **Do not use any of the following types of liquid.**
Warm water (40°C or above), unclean water, water containing aroma oil, chemical agents such as hypochlorous acid, aromatic substances or detergent, etc.
(Deformation of the unit or malfunction may result)
Water from a water purifier, ionised alkaline water, mineral water, well-water etc.
(Clogging of the metal filter of the water tank and growth of mould/bacteria may result)
- **Be careful of freezing.**
(Malfunction may result)
Discard any water in the water tank and humidifying tray if there is any risk of freezing.
- **When not using the Humidifying operation, discard any water in the water tank and humidifying tray.**
(Bad odours may result from the propagation of mould or bacteria in dirt and water scales)
- **Depending on the usage environment, shorten the maintenance period. When using in places with high foot traffic such as hotels and public facilities, shorten the pre-filter maintenance period.**
(If the pre-filter becomes clogged and the unit continues to be used, malfunction may result)

Do not use in the following places

- **Positions from where out flowing air flows directly at a wall, furniture, curtains, etc.**
(Staining or deformation may result)
- **On top of a thick carpet, bed cover or mattress**
The unit may tilt causing water to spill or the water level sensor may fail to work correctly.
- **Places exposed to direct sunlight**
(Discolouration, deterioration of plastic parts, and cracking may result)
- **Places exposed to outdoor air (e.g. near windows, etc.) or direct airflow from air conditioners, etc.**
Room humidity and temperature may not be detected and indicated correctly.
- **Places with high levels of electromagnetic waves such as near an electromagnetic cooker, speakers, etc.**
The unit may not function correctly.
- **Positions near combustion-based heating devices or exposed to direct airflow from heating appliances**
(Room humidity and temperature may not be detected and indicated correctly or deformation may result)
- **Places where chemicals and pharmaceuticals are used such as hospitals, factories, laboratories, beauty salons, and photographic laboratories**
(Volatilized chemicals and solvents may degrade mechanical parts, cause water leaks and cause things to get wet, such as household items, etc.)
- **Places exposed to soot (conductive dust) released by candles, aromatic candles, etc.**
The performance of the filters may be impaired, causing the room to become dirty due to the build-up of dust that is not captured.
- **Do not use cosmetics etc., containing silicone* near the unit.**
* Hair care products (split ends coating agents, hair mousse, hair treatment agents etc.), cosmetics, antiperspirants, antistatic agents, waterproof sprays, lustering agents, glass cleaners, chemical wiping cloths, wax, etc.
 - Insulators such as silicone may adhere to the needle of the streamer unit, and the streamer discharge may not be generated.
 - The dust collection filter may become clogged up, resulting in loss of air purifying capacity.
- **Do not use an ultrasonic humidifier or similar appliance near the unit.**
The dust collection filter may become clogged up, resulting in loss of air purifying capacity.
- **This unit is not intended for use at high altitudes (above 2000m).**

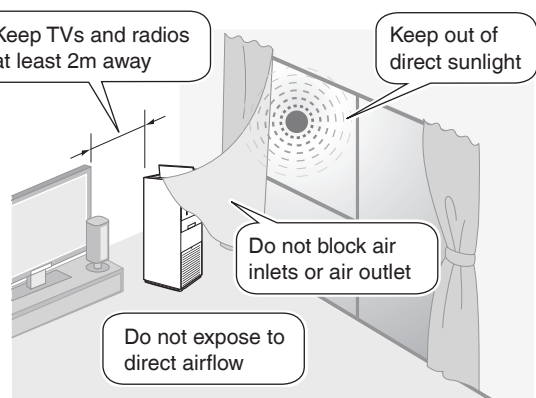

About streamer discharge and active plasma ions

In some cases the air outlet may emit a slight odour as trace amounts of ozone are generated. However, the amount is negligible and is not harmful to your health.

- **This product cannot eliminate all of the toxic substances in tobacco smoke (carbon monoxide etc.)**
- **Odours cannot be completely removed if they are being constantly generated (building material odours, pet odours, etc.)**

Names of Parts and Operations

⚠ CAUTION

Do not lift up the unit holding the grip on the water tank or humidifying tray. (Injury may result from the unit falling)

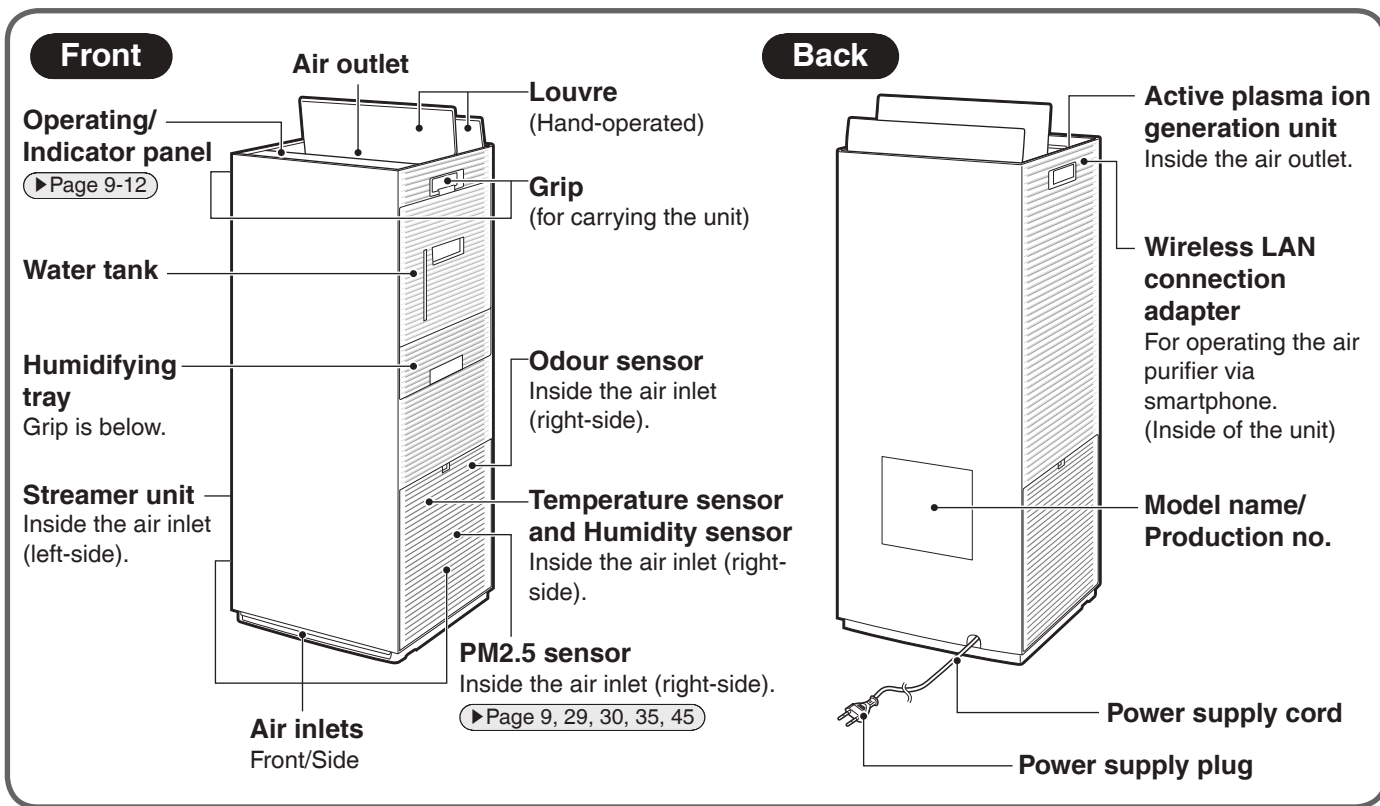

Main Removable Parts

Attention

To prevent injury or malfunction, be sure to only operate the unit with all parts attached.

Streamer unit cover

Do not remove streamer unit cover.

Dust collection filter

(White filter)

(▶Page 36, 43, 45)

Deodorising filter

(Black filter)

(▶Page 14, 15, 36, 45)

Humidifying filter unit

(▶Page 36, 39-41)

Water tank

(▶Page 16, 17, 36-38)

Filter fixing unit

(▶Page 15, 36)

Humidifying tray

(▶Page 36, 39)

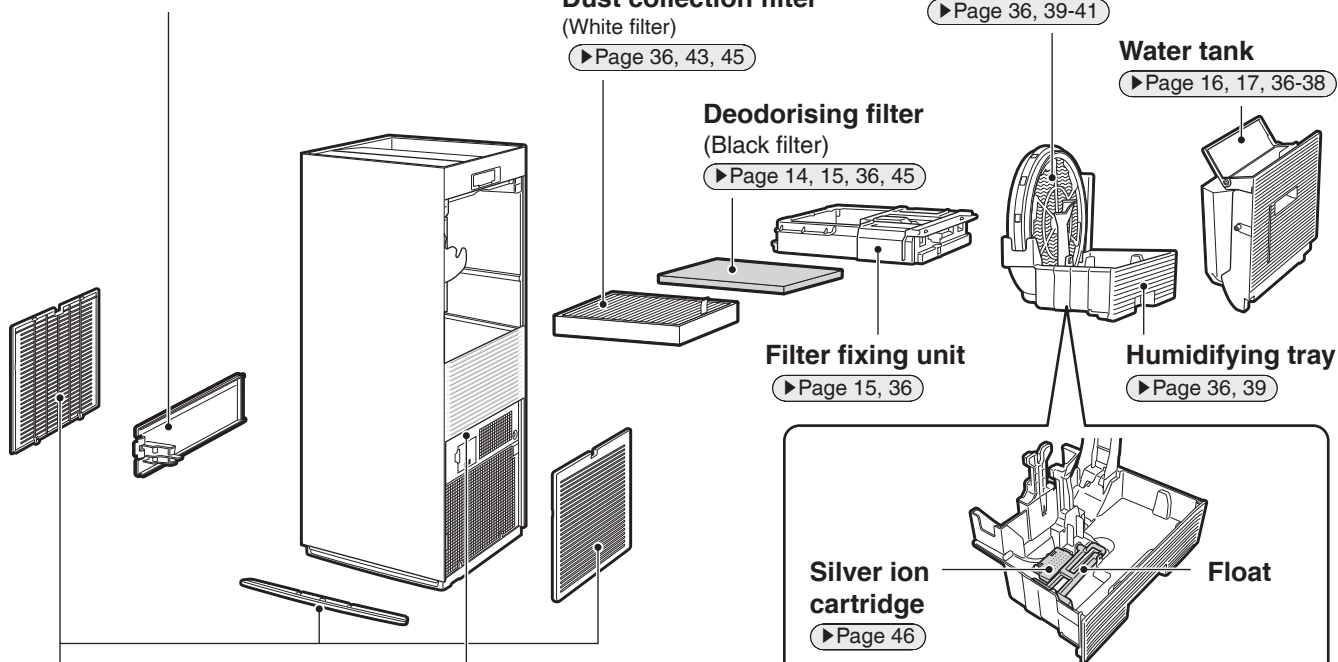

Do not remove both the silver ion cartridge and float.

Names of Parts and Operations

Operating / Indicator panel

Operations and operating status will be notified by tones.

- Operation start..... 2 quick beeps
- Setting change..... 1 short beep
- Operation end..... 1 long beep
- When not usable..... 3 short beeps
- Notification..... 3 long beeps

Water supply lamp (Red)

- When water in the water tank is depleted during Humidifying Operation, a tone (3 long beeps) will sound and the lamp will light up.
- Stop operation, unplug the power supply plug, and then fill the water tank with water. [▶Page 16, 17](#)
- To stop the notification tone (3 long beeps) from sounding, change the setting. [▶Page 33, 34](#)
- If 3 long beeps sound and the lamp lights up even though water is in the water tank. [▶Page 50](#)

Streamer lamp (Blue)

Lights up according to the operation status of the streamer. [▶Page 28](#)

Humidity sensor lamp

Indicates the level of humidity in 3 colours: blue, orange, red.

Lamp colour	Red	Orange	Blue	Orange	Red
Indoor humidity (%)	0-20	21-29	30-60	61-70	71-100

- After operation is started, the lamp will light blue for about the first 30 seconds regardless of humidity level.

PM2.5 sensor lamp

Indicates the volume of dust in 3 colours: blue, orange, red.

- Blue indicates that the air is clean.

Lamp colour	Blue	Orange	Red
PM2.5 concentration (µg/m ³)	0-12	13-24	≥ 25

- After operation is started, the lamp will light blue for about the first 1 minute regardless of volume of dust.

Daikin eye

Displays the condition of the air selected with **AIR MONITOR** in 3 colours: blue, orange, red.

- If “µg/m³” is selected
Lights up in the same colour as the PM2.5 sensor lamp.
- If “°C” is selected
Lights up in the colours displayed below, according to the current indoor temperature.

Lamp colour	Red	Orange	Blue	Orange	Red
Indoor temperature (°C)	≤ 10	11-17	18-28	29-35	≥ 36

- If “%” is selected
Lights up in the same colour as the humidity sensor lamp.

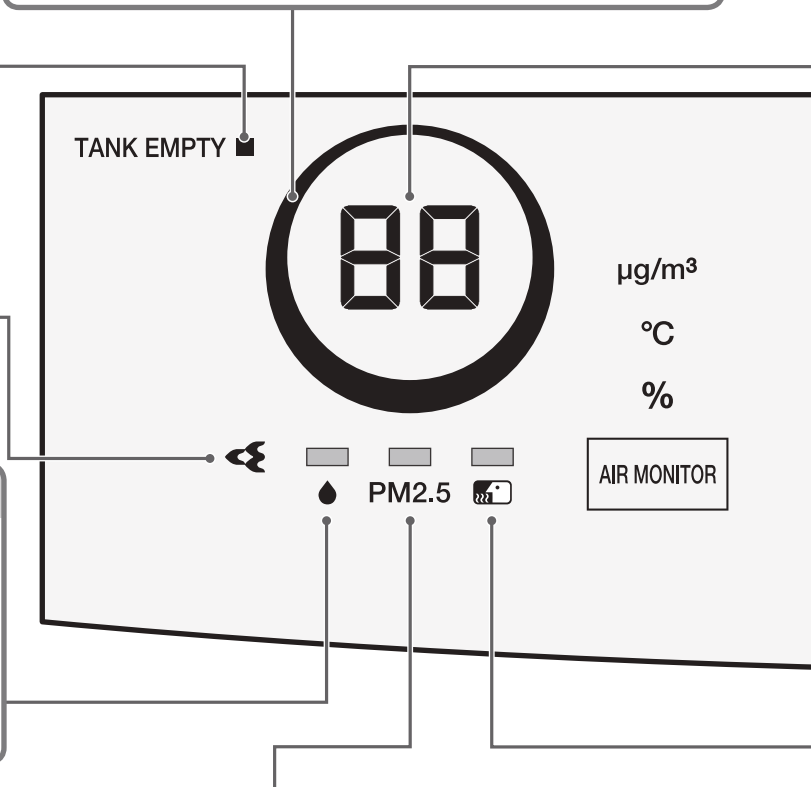

- If the responsiveness of the PM2.5 sensor is poor, change the sensitivity setting of the sensor. [▶Page 29, 30](#)

- The responsiveness of the PM2.5 sensor may be poor when airflow rate is high such as “Turbo”. This is not a malfunction because the airflow rate is strong and the dust is sucked into the air inlet before it reaches the PM2.5 sensor.

PM2.5 sensor detection range

Detectable matter
house dust, tobacco smoke, pollen, mite droppings and remains, pet hairs, diesel particulate matter
Sometimes detectable
steam, oil smoke

Names of Parts and Operations

Operating / Indicator panel

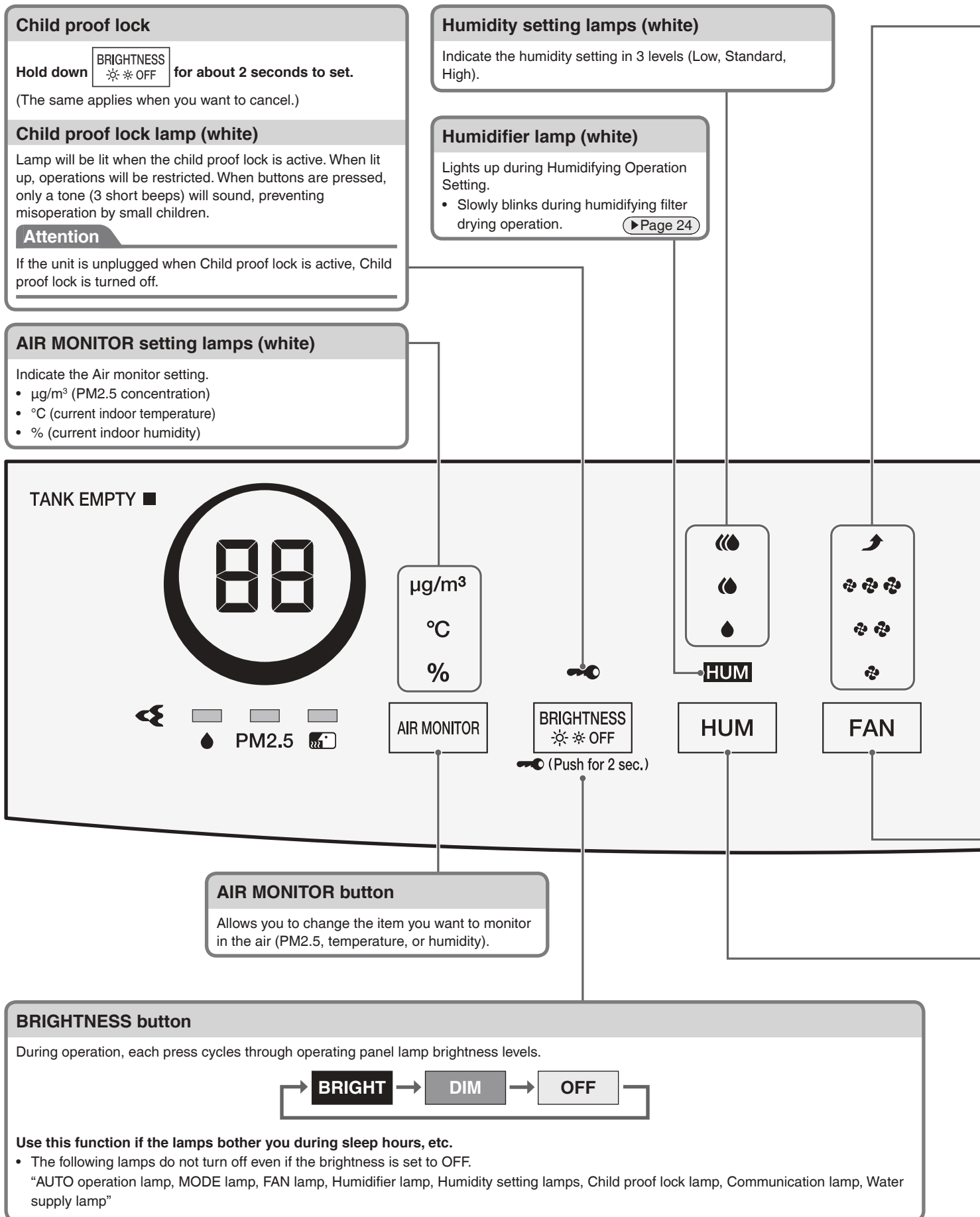

FAN lamps (white)

Indicate the active FAN setting in 4 levels (Quiet, Low, Standard, Turbo).

MODE lamps (white)

Indicate the MODE in operation.

AUTO operation lamp (white)

Lights up during AUTO operation. (▶Page 21)

**Communication lamp
Communication ON/OFF button**

Used when operating the air purifier via smartphone.

- Each press cycles between communication “ON” and “OFF”. The communication lamp lights up if communication is set to “ON”.
- Perform connection settings before using. (▶Page 18-20)

AUTO button

Optimum operation will be performed according to the condition of the room. (▶Page 21)

ON/OFF button

Press to turn the power ON, press again to turn OFF.
After operation stops, humidifying filter drying operation may be performed. (▶Page 24)

MODE button

Press to select the desired MODE. (▶Page 24)

FAN setting button

Press to select the desired airflow rate. (▶Page 22)

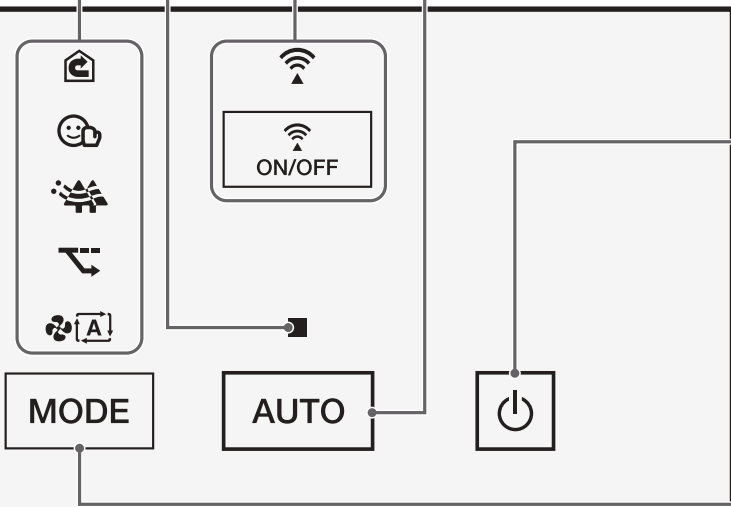

HUM setting button

Press to turn the Humidifying Operation ON/OFF and to select the humidity setting. (▶Page 23)

- Humidifier lamp turns off when humidification is set to “OFF”.

About the airflow rate and humidity setting symbols

Symbol table

	Fan				Humidity setting		
Symbol							
Setting	Quiet	Low	Standard	Turbo	Low	Standard	High

Be sure to stop the operation and remove the power supply plug before installation. (Electric shock or injury may result)

Preparation Before Operation

1 Checking accessories

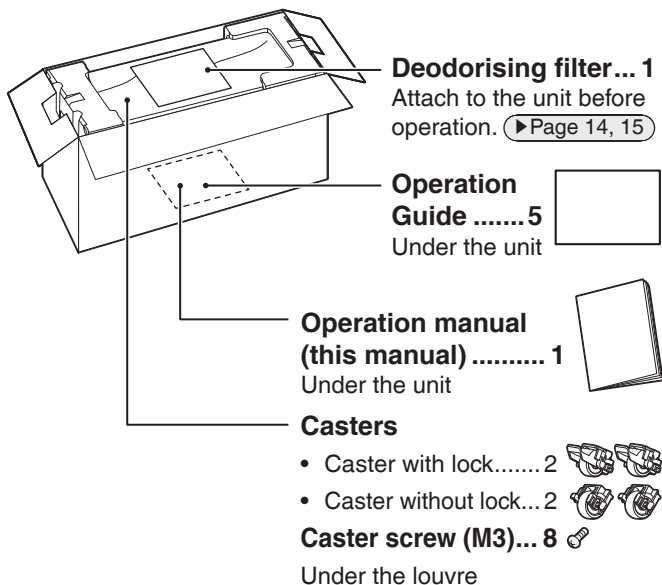

2 Positioning the unit in the room

Before setting up, remove the fixing tape on the bottom which is securing the power supply cord, then take out the power supply cord.

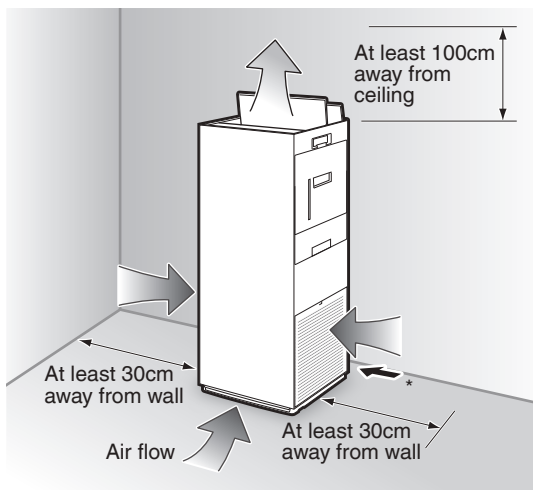
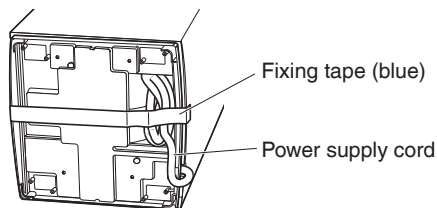

* Keep distance from the wall so that the power supply cord doesn't bend tightly. (May cause damage or heating)

Pointers for good positioning

- Choose a place from where airflow can reach all areas of the room.
- Place the unit on a stable surface. If the unit is placed on an unstable surface, vibrations from the unit may be amplified.
- If interference from the power circuit inside the unit or cables causes disturbance of TV screen images or the emission of static noise from nearby radios or stereos, move the unit to at least 2m away from the device. Keep cordless phones and radio-controlled clocks away from the unit also.
- This unit contains radio transmitter; the minimum separation distance between the radiating part of the equipment and the user is 30cm.

Attention

- To avoid staining of walls, position the unit in accordance with the positioning measurements in the illustration. However, note that since this unit draws in dirty air, certain types of wall may become stained even if the measurements in the illustration are adhered to. In such cases, be sure to maintain sufficient distance between the unit and the wall.
- When used for a prolonged period in the same place, the base of the unit and the floor and surrounding walls may become stained as air is drawn into air inlets near the base of the unit. Periodic cleaning is recommended.
- Place the unit on a flat surface.

3 Attaching the casters

⚠ CAUTION

Before attaching the casters, make sure to unplug the unit and discard any water in the water tank and humidifying tray. (Malfunctioning may result)

1. Place down the unit so that the front of the unit faces upward.

- The front may be scratched if faced downward.

2. Tighten securely using the included screws to prevent rattling.

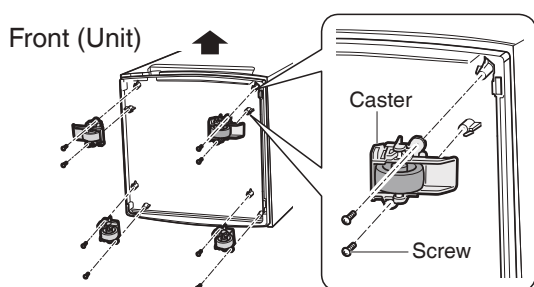

Attachment orientation

- Attach the casters with lock to the corners at the front of the unit.

Position the casters as in the illustration below.

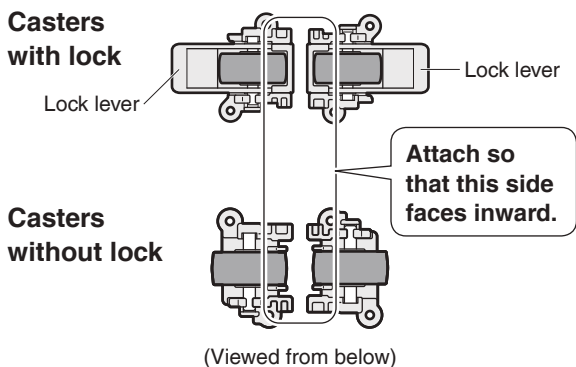

Attention

- Do not use the lock levers while attaching the casters, as it may cause the wheels to detach.
- Engage the lock levers after installing the product in the desired location.
- When moving the unit with the casters, make sure to move it slowly as floor surfaces may be scratched depending on the flooring material.

How to use

- There are 2 lock levers at left and right side.

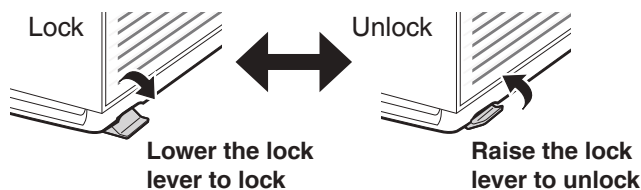

Attention

- Please use your hands to operate the lock levers.
- When operating the product, use it with the lock levers engaged.

4 Attaching the deodorising filter

1. Take out the water tank.

- ① Securely hold the grip on the water tank and slowly pull the tank toward you while pressing the lever.

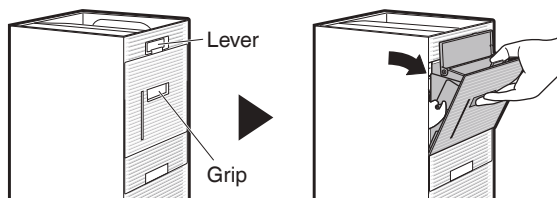

- ② Take out the water tank by holding down the side lock part on the water tank with a finger to unlock.

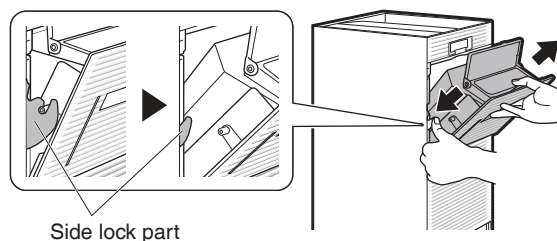

- When releasing the side lock part, be sure to support the water tank with your hand. (Water tank may fall)

Preparation Before Operation

⚠ WARNING

Be sure to stop the operation and remove the power supply plug before installation. (Electric shock or injury may result)

2. Remove the humidifying tray.

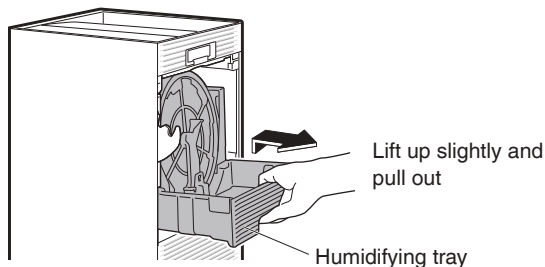

3. Remove the filter fixing unit.

① Slide the fixing tab on the filter fixing unit to side to unlock.

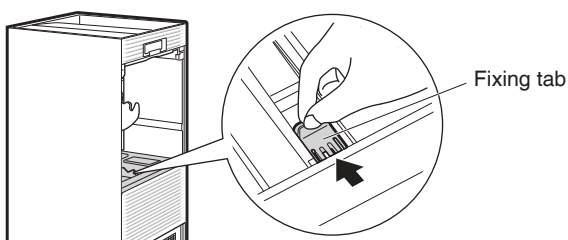

② Lift up the grip in the upper part of the filter fixing unit and pull toward you.

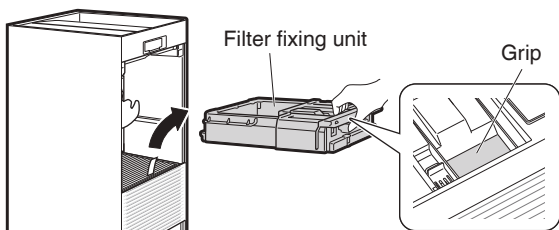

4. Remove the deodorising filter from the bag.

- The deodorising filter has no front or back.

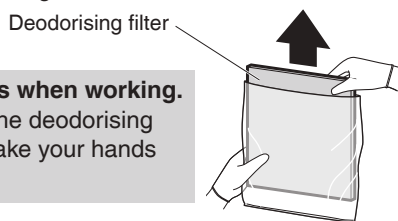

Wear gloves when working.
(Dust from the deodorising filter may make your hands dirty.)

- Observe local waste separation rules when disposing of the deodorising filter bag and desiccant.

5. Attach the deodorising filter.

Insert the short-side of the filter all the way into the unit and place it on the dust collection filter.

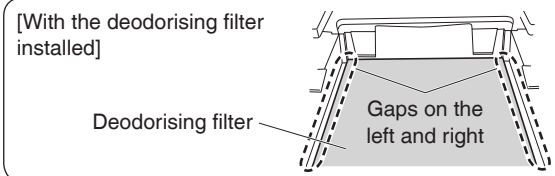
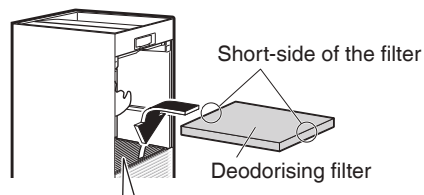

Dust from the deodorising filter may turn the dust collection filter black, but it does not affect dust collection performance.

6. Attach the filter fixing unit.

Attach the filter fixing unit and slide the fixing tab to side to lock.

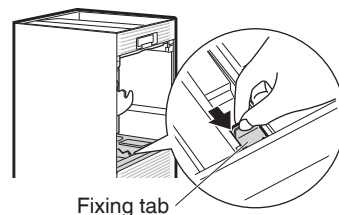

Attention

Be sure to lock the filter fixing unit. If the unit is operated without locking the filter fixing unit, abnormal noise may occur or the performance may deteriorate.

7. Attach the humidifying tray.

8. Install the water tank. ▶Page 17

- To perform the Humidifying Operation, carry out **5 Preparing the water tank** before installing the water tank.
- When starting operation, if a notification tone sounds and the odour sensor lamp blinks, the deodorising filter and the filter fixing unit are not properly installed. Re-install the deodorising filter and the filter fixing unit.
- Do not touch the side lock part when installing the water tank. (Fingers may get caught)

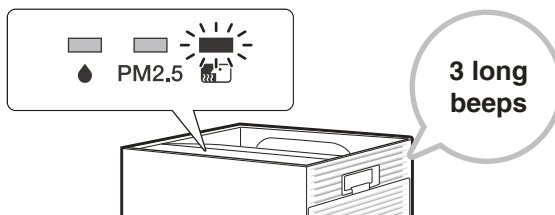

5 Preparing the water tank (for Humidifying Operation)

Attention

- Do not pour any of the following into the water tank.
 - Warm water (40°C or above), unclean water, water containing aroma oil, chemical agents such as hypochlorous acid, aromatic substances or detergent, etc. (Deformation of the unit or malfunction may result)
 - Water from a water purifier, ionised alkaline water, mineral water, well-water etc. (Propagation of mould or bacteria may result)
- As leaving any residual water in the humidifying tray will lead to bad odours and dirt build-up, be sure to discard any residual water in the humidifying tray once a day to perform the Humidifying Operation. Fill the water tank with water and check that there is no water leaking from the bottom of the tank due to dirt trapped in or around the valve. If there is water leakage, bad odours or dirt build-up [▶Page 36-39](#)
- Do not pour water directly into the humidifying tray.
- Make sure to close the water tank tightly before operation. (Dust may get inside the tank and cause water leakage)

When supplying water from above

1. Open the water tank.

Securely hold the grip on the water tank and slowly pull the tank toward you while pressing the lever.

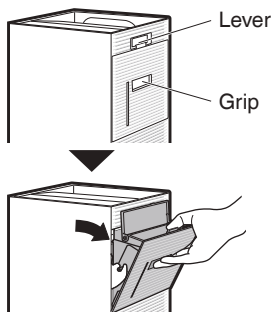

Open to the position where it will be locked.

2. Slowly pour water into the spout of the water tank with a jug.



- Do not touch the lid of the water tank when fitting into the unit. (Fingers may get caught)
- Do not touch the side lock part when pouring water. (Water tank may fall)
- When supplying water, clean the water tank every day by shaking a small amount of water inside to perform the Humidifying Operation. [▶Page 37, 38](#)
- Do not pour water other than the spout. (Malfunction may result)
- Do not pour water beyond the full line inside the spout. (Water leakage may result)

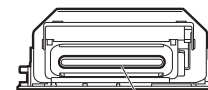

Full line

3. Close the water tank

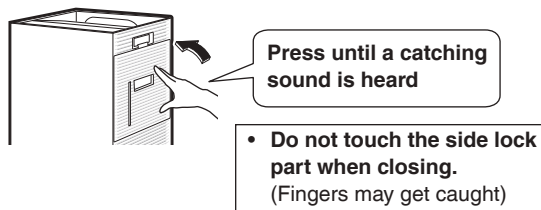

Preparation Before Operation

⚠ WARNING

Be sure to stop the operation and remove the power supply plug before installation. (Electric shock or injury may result)

When supplying water in the water tank

1. Take out the water tank.

- ① Securely hold the grip on the water tank and slowly pull the tank toward you while pressing the lever.

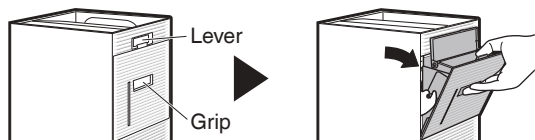

- ② Take out the water tank by holding down the side lock part on the water tank with a finger to unlock.

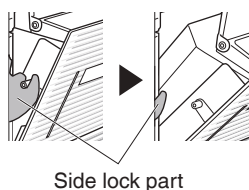

- When releasing the side lock part, be sure to support the water tank with your hand.

2. Fill the water tank with tap water.

- Perform in a place where spilling water will not cause a problem.
- Clean the water tank by shaking a small amount of water inside before filling up the water tank with water. For maintenance procedures refer to

▶Page 37, 38

[Viewed from below]

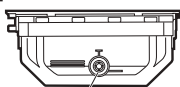

Avoid touching the valve in the centre.
(Water in the water tank may leak)

- **Do not remove the lid of the water tank when filling with water.**
(Water leakage may result from foreign matter entering the tank)
The metal filter at the spout prevents foreign matter from entering.
- The water tank will weigh about 3.3kg when filled up to the full line.
Hold the water tank firmly with both hands when carrying.

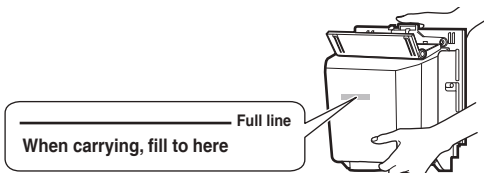

- Do not supply water beyond the full line of the water tank.
(Water may spill when carrying the water tank or installing it into the unit)
- Since the top surface is not sealed, water will spill if the tank is tilted too much.
- If the water tank contains water, do not place it on the floor or carpet. (The valve in the centre may be pushed and water may spill)

3. Install the water tank.

- Hold the grip and install the water tank in the unit by fitting it into the humidifying tray.

• **Do not touch the side lock part when installing.**
(Fingers may get caught)

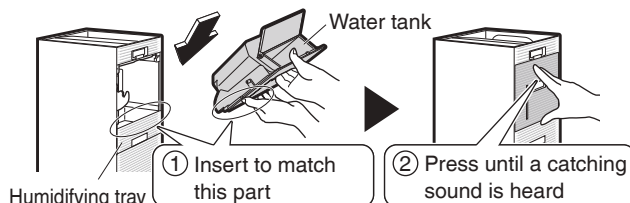

6 Insert the power supply plug into the power socket

- The basic sensitivity of the odour sensor will be determined by odour levels in the first minute (approx.) after the power supply plug is inserted.

Insert the power supply plug when the air is clean (odour-free).

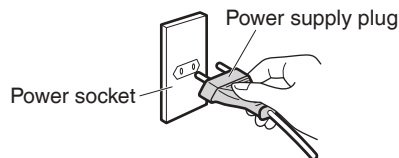

Operating the air purifier via smartphone

When you want to operate the air purifier via smartphone

By connecting your smartphone to the air purifier via wireless LAN, you can operate the air purifier from your smartphone via the Internet. (Setting at time of purchase: "OFF")

Wireless LAN connection adapter specifications: Supported standards IEEE802.11b/g/n (HT20) (2.4GHz only), Channels 1 to 13CH

Use with the following network environments (wireless LAN routers)

Encryption method: WPA-PSK (AES), WPA2-PSK (AES)

IP configuration method: DHCP or a fixed IP address

Communication standard: IPv4

(HTTP proxy is not supported)

Precautions During Use of Wireless LAN

- **Because wireless LAN uses radio waves to send and receive data, there is a risk of eavesdropping and unauthorized access.**

When using wireless LAN, be sure to fully understand the dangers, and secure the product's wireless LAN connection adapter so that others cannot connect to it. This means keeping your wireless LAN router SSID/KEY, app login ID, and password secret from others. (▶Page 8)

If someone who is unauthorized gains access to and operates this product, turn off the wireless LAN connection adapter using the communication ON/OFF button. (▶Page 12, 20)

- **Please be aware in advance that we will not be liable for any damages that arise if you use this product without taking security measures.**
- **Using near other wireless LAN equipment or microwave ovens may affect wireless LAN communication.**
- **This product cannot be directly connected to the communication line of a telecommunications carrier (Internet provider, etc.).**
When connecting to the Internet, be sure to connect via a router, etc.

WARNING

- If the air purifier is located in a place which may be used by people with cardiac pacemakers, do not turn on the wireless LAN connection adapter with the communication ON/OFF button.
(It may affect the operation of pacemakers or other devices, causing trouble.)
- Do not turn on the wireless LAN connection adapter near people with cardiac pacemakers or defibrillators.
(If it is too close, radio waves may affect the operation of the pacemaker or other devices)
- Do not turn on the wireless LAN connection adapter near automatic control devices such as automatic doors.
(Accidents may result due to device malfunction)

For detailed specifications, installation instructions, setting methods, FAQ, declaration of conformity and the latest version of this manual, visit <http://www.onlinecontroller.daikineurope.com>.

INFORMATION

Hereby, Daikin Industries, LTD. declares that the radio equipment type MCK70ZVM-W, MCK70ZVM-H is in compliance with Directive 2014/53/EU.

Basic parameters of Wireless LAN connection adapter

What	Value
Frequency range	2412~2472MHz
Radio protocol	IEEE 802.11b/g/n (HT20)
Radio frequency channel	13ch
Effective isotropic radiated power	17.15dBm (11b) / 16.22dBm (11g) / 16.24dBm (11n)
Power supply	DC 14V / 100mA

Operating the air purifier via smartphone

Preparation Before Connection

The customer is responsible for providing:

- Smartphone or tablet with minimum supported version of Android or iOS, specified on app.daikineurope.com.
- Internet line and communication device, such as a modem, router, etc.
- Wireless LAN access point
- Installed free ONECTA app

Note: If needed, the SSID (Service Set Identifier) and the KEY (password) are located on the unit.

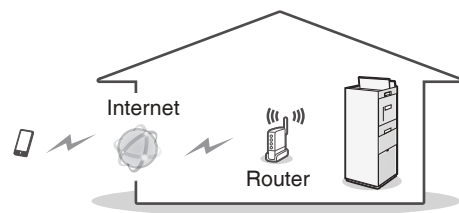

⚠ WARNING

When operating the air purifier from outside the home, it is not possible to check the condition of the air purifier, its surroundings, people in the room, etc., so be sure to adequately check the safety in advance before using it. Depending on the circumstances, people may be killed or seriously injured, or property damage may result.

■ **Check the following in advance (while at home)**

- Make sure that the power supply plug is firmly inserted all the way to the base.
There should be no dust buildup on the power supply plug. (Heating, ignition, and fire may result due to poor contact and defective insulation)
- Make sure that there are no existing schedule timer reservations set by another person.
(May cause poor physical condition due to unexpected start or stop of operation. May cause adverse effects to plants and animals)
- Make sure there are no problems with the air purifier. Make sure that changes in airflow will not adversely affect people in the room. (Make sure there are no objects that can fly away)
(Airflow may cause objects to fall, resulting in fire, injury or stains on household items)



■ **Check the following before and while operating the air purifier from outside the home**

- If you know that there are people at home, let them know that you will start or stop operation remotely.
(If someone is at home standing on a stool or ladder, they may be surprised at the sudden start or stop of operation, and may fall off the stool or ladder. Also, bad physical condition may be caused by sudden changes in the indoor environment)
- Operation of the air purifier can be started and stopped by pressing the buttons on the air purifier itself, even when it is being operated from outside the home.
- Do not operate the air purifier remotely if there are people in the room who cannot operate it by themselves, such as small children, people with disabilities, elderly people, etc.
- Frequently check the settings and operating conditions.
Bad physical condition and adverse effects to plants and animals may be caused by sudden changes in the indoor environment. If an error occurs with the air purifier, stop operation immediately and contact the place of purchase.
Check again via the operation screen to make sure that operation is stopped.

Connection settings

1 Check if router has WPS built-in

2 If router has built-in WPS Connect air purifier to network

- 1 Press  to activate the wireless LAN connection adapter.
- 2 Press and hold  for about 5 seconds and, once the communication lamp on the unit flashes orange, press the WPS button* on the router within 2 minutes.
 - How to operate the WPS button varies by router.
For details, refer to the manual supplied with the router.

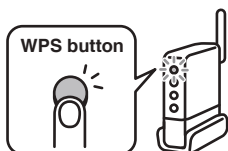

* If using an automatic connection function other than WPS, refer to the manual attached to the router when operating the automatic connection button.

• **Setting is complete once the communication lamp on the unit lights green.**

- The lamp may light red before turning green, until the connection between the wireless LAN connection adapter and the router is complete, depending on the communication environment; however, this is not a malfunction.

If the communication lamp on the unit lights orange, repeat steps 1 to 2. If connection continues to fail, follow the steps in

If router does not have built-in WPS ▶ Page 20

- 3 **Connect your smartphone and router via wireless LAN.**
 - Open wireless LAN in settings on the smartphone to check that your smartphone is connected to the SSID of the router in use.
- 4 **Launch the app and establish settings.**
 - Open the installed app "ONECTA" and operate in accordance with the on-screen guidance.
- 5 **Operate the air purifier.**
 - You can now operate the air purifier using your smartphone at home or on the go.

2 If router does not have built-in WPS Connect air purifier to network

Follow the steps below even if you are choosing to not use WPS.

- ① Press  to activate the wireless LAN connection adapter.
- ② Launch the app and follow the guidance to connect the air purifier and router.
 - SSID and KEY are required for connection.
(A sticker with the SSID and KEY can be found in the location shown in the illustration on the right.)

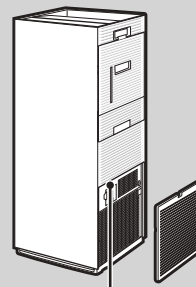

Location of SSID and KEY

For detailed specifications, installation instructions, setting methods, FAQ, declaration of conformity and the latest version of this manual, visit app.daikineurope.com.



Communication lamp status

Lights up or blinks according to the wireless LAN communication status, as shown below.

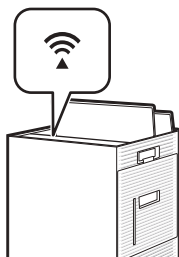

Lit up	Green	Wireless LAN connection adapter is connecting to router
	Orange	<ul style="list-style-type: none"> • Wireless LAN connection adapter and router connection not set • Wireless LAN connection adapter is connecting to router (immediately after turning communication "ON")
	Red	Wireless LAN connection adapter cannot connect to the Internet
Unlit		Wireless LAN connection adapter function is "OFF"

If the unit (air purifier) can't be found with the app

- Perform connection settings again.
- Move the router closer to the air purifier.

If you want to turn the wireless LAN connection adapter function "OFF"



Press  .

■ If you want to turn the adapter function "ON", press  again.

if necessary If you want to reset the wireless LAN connection adapter to factory default settings

- If you want to redo the settings, etc., the wireless LAN connection adapter can be reset to the factory default settings from the time of purchase.
If you reset to factory default settings, network settings will be erased, as well as historical data such as the number of sensor responses.
- If disposing of the unit or transferring it to a new user, reset it to factory default settings in order to erase the internal data.

① Press  to turn on the communication lamp.

② Press and hold  and  at the same time for about 5 seconds while the unit is stopped.

- A short beep sounds, and the communication lamp (orange) and the AUTO operation lamp (white) blink for about 20 seconds.
- When reset to factory default settings is completed, a long beep sounds and all lamps turn off.
- If, after step ②, the communication lamp lights up and only the AUTO operation lamp turns off, repeat steps ① and ②.

WARNING

Do not turn off the unit by removing the power supply plug during operation. (Fire due to overheating or electric shock may result)

Operation

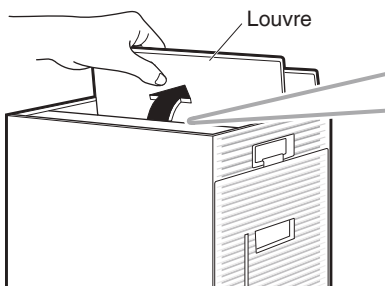

Please open the louvre by hand before operation. (As the louvre is hand-operated, it will not close automatically at operation end.)

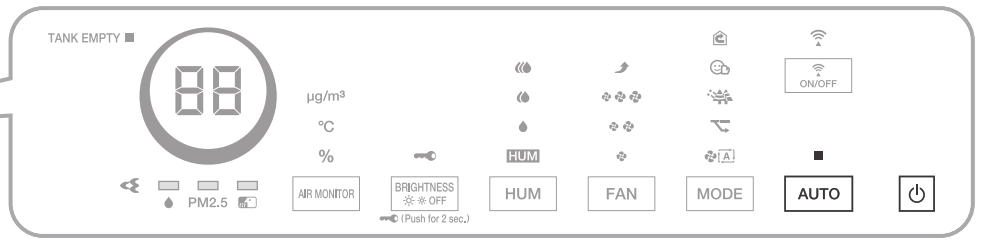

If you want to change the airflow direction

Adjust the louvre to the desired position. The louvre can adjust the airflow in 4 directions.

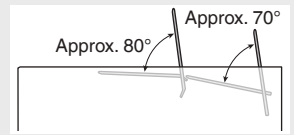

When you want to let the unit decide the best operation mode (AUTO operation)

Fill the water tank with water. (▶Page 16, 17)

Attention

- Make sure that the humidifying filter unit is attached when performing this operation.
- Change the water in the humidifying tray and water tank every day.
- Be sure to use tap water for the water in the water tank.

Press **AUTO**.

- Optimum operation will be performed according to the condition of the room.
- The AUTO operation lamp (white) lights up.
- If **AUTO** is pressed during AUTO operation, the lamp corresponding to the current operation mode will blink for about 5 seconds.

Operation mode	MODE lamp	Humidity setting lamps	ECONO MODE lamp
Air Purifying Operation	(AUTO FAN)	–	–
Humidifying Operation	(AUTO FAN)	Either “ (Low)”, “ (Standard)”, or “ (High)”	–
Monitoring mode	–	–	Blinking

About AUTO operation

The unit automatically switches between Air Purifying Operation and Humidifying Operation based on the indoor temperature and humidity conditions.

- The airflow rate is adjusted automatically. If the operating sound bothers you, the airflow rate range can be changed. (▶Page 31, 32)
- If the humidity is high, Air Purifying Operation will be carried out.
- If the air is clean and the set humidity has been reached (during Humidifying Operation) for about 5 minutes, the mode automatically switches to Monitoring mode.

(▶Page 25)

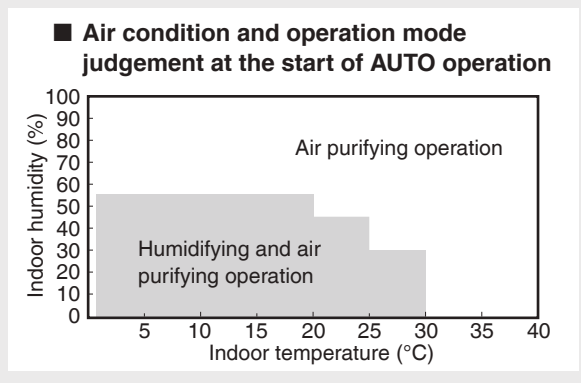

- Pressing during operation will cause operation to stop. After Humidifying Operation stops, humidifying filter drying operation may be performed automatically. (▶Page 24)
- If you want to stop humidifying filter drying operation, press again.

Note

- The humidifier lamp lights up during Humidifying Operation.
- The room temperature may drop during Humidifying Operation.
- Splashing sounds may be heard during Humidifying Operation, but this is not a malfunction. (▶Page 48)
- If the set humidity is reached or the water supply lamp lights up during Humidifying Operation, Humidifying Operation will stop, but Air Purifying Operation will continue.



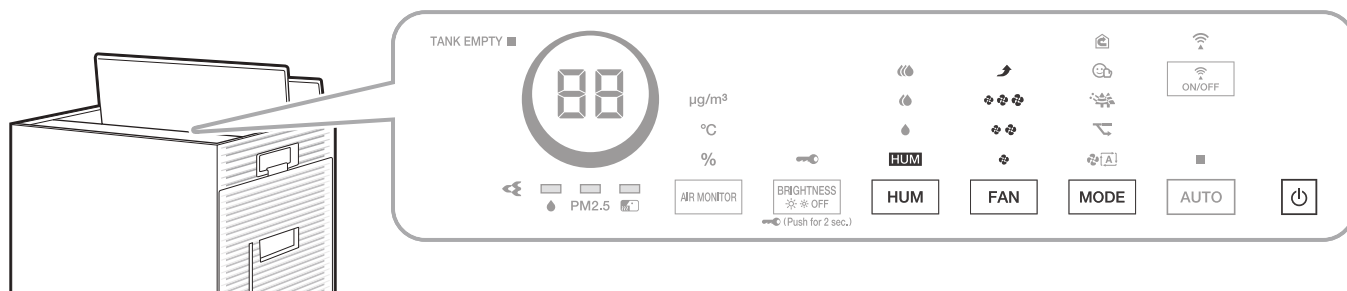

Attention

Do not move the unit, or attach or remove parts to/from the unit while it is in operation. Water leakage, breakage or malfunction may result.



Air Purifying Operation

Press .

- Press again to turn OFF.
If Humidifying and Air Purifying Operation was running within the past 1 hour, humidifying filter drying operation may be performed. (▶Page 24)
If you want to stop humidifying filter drying operation, press  again.
- If AUTO operation was in progress last time, AUTO operation will be performed automatically, and press  or  if you want to perform only Air Purifying Operation.
- If Humidifying Operation was running previously, Humidifying Operation will start automatically, and press  until the humidifier lamp turns off if you want to perform only Air Purifying Operation.

Attention

When performing only Air Purifying Operation, discard the water in the water tank and humidifying tray.

Note

- At the time of purchase, the unit is set to carry out Air Purifying Operation in “AUTO FAN MODE”.
- If the power supply plug is unplugged, or the unit is stopped and started again, the operation that was in progress last time will start again.
- Operation settings cannot be changed for about 2 seconds immediately after the power supply plug is inserted.

Changing the Airflow Rate

Press  during operation to change the airflow rate.

- Each press cycles between the FAN lamps (white).



Quiet

A gentle breeze is emitted. Recommended for use during sleep hours. As the deodorising capacity is reduced, it is recommended that the FAN setting be set to “Standard” or above if odour needs to be quickly eliminated from a room.

Turbo

The ambient air is quickly purified using a large airflow rate. Recommended for use while you are cleaning up a room.

Operation

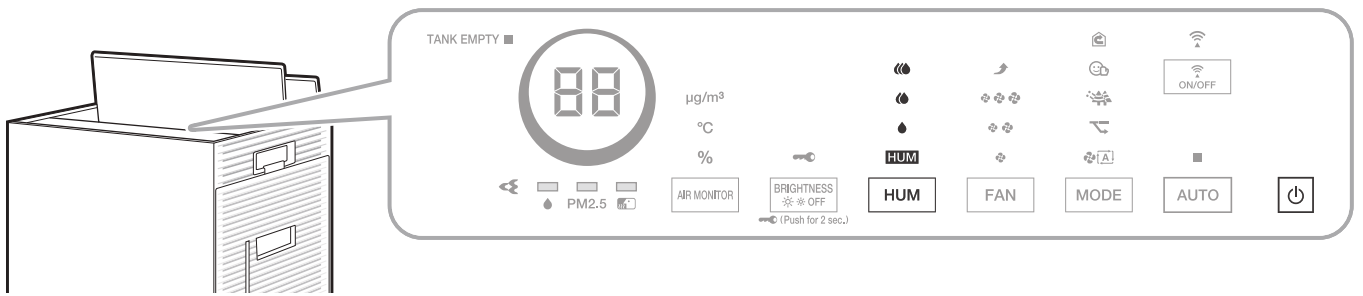

Humidifying and Air Purifying Operation

Fill the water tank with water. (▶Page 16, 17)



1. Press .

2. Press  to switch the humidity setting.

- Each press cycles between the humidity setting lamps (white).



- Pressing  during operation will cause operation to stop. After operation stops, humidifying filter drying operation will start automatically.

-  **Low** Operation is carried out automatically with a humidity of 40% (*) as a rough estimate.
-  **Standard** Operation is carried out automatically with a humidity of 50% (*) as a rough estimate.
-  **High** Operation is carried out automatically with a humidity of 60-70% (*) as a rough estimate.

When the target humidity is reached, the humidifying filter unit will stop.

* Depending on the indoor and outdoor temperature and humidity, and the room conditions, the target humidity may be exceeded (or not reached). (▶Page 52, 53)

Attention

- Make sure that the humidifying filter unit is attached when performing this operation.
- Change the water in the humidifying tray and water tank every day.
- Be sure to use tap water for the water in the water tank.
- **As leaving any residual water in the humidifying tray will lead to bad odours and dirt build-up, be sure to discard any residual water in the humidifying tray once a day to perform Humidifying Operation.**

- Perform during Humidifying Operation as well as Air Purifying Operation. (Humidification only operation cannot be performed.)
- Even if you have selected an airflow rate that suits your preferences, if the water supply lamp lights up, the airflow rate will change to “Quiet”. If you do not want the airflow rate to change to “Quiet”, change the setting. (▶Page 33, 34) (Depending on the degree of odour and dust, the airflow rate may not change to “Quiet”.)
- In order to make it easier for the humidifying filter to absorb water, the “Turbo” airflow rate will be suppressed for about 10 minutes from the start of the humidifying operation. After that, the operating sound changes because the airflow rate also changes to the set airflow rate.

Note

- No steam (vapor) or fog can be seen.
- The room temperature may drop during Humidifying Operation.
- Splashing sounds may be heard during Humidifying Operation, but this is not a malfunction. (▶Page 48)
- If the set humidity is reached or the water supply lamp lights up during Humidifying Operation, Humidifying Operation will stop, but Air Purifying Operation will continue.

WARNING



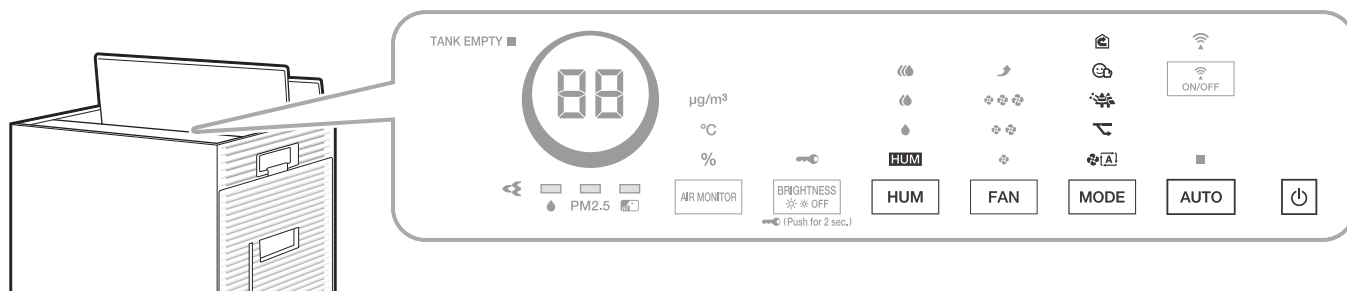

Do not move the unit, or attach or remove parts to/from the unit while it is in operation. Water leakage, breakage or malfunction may result.



About Humidifying Filter Drying Operation

Setting at the time of purchase: "ON"

After stopping Humidifying and Air Purifying Operation using , perform Air Purifying Operation with the airflow rate reduced for about 1 hour to dry the humidifying filters, shortening the period when the filters are left semi-damp and bacteria is likely to propagate.

- The humidifier lamp (white) slowly blinks.
- If Air Purifying Operation is performed for 1 hour or more after Humidifying and Air Purifying Operation, humidifying filter drying operation will not be performed.
- If you do not want to perform humidifying filter drying operation, change the setting. [▶Page 33, 34](#)
- If you want to stop humidifying filter drying operation while in progress, press .
- If you press ,  or  during humidifying filter drying operation, humidifying filter drying operation will end and the airflow rate and mode will be set according to the button pressed, or AUTO operation will be performed.

Operating MODEs

Optimal operation is performed by selecting the mode that suits the application. The airflow rate is adjusted automatically when the unit is operated in a mode.

Press  during operation.

- Each press cycles through the MODE lamps (white).



Note







- The humidifier is turned ON when MOIST MODE is selected.
- Even if you select a mode other than MOIST MODE, if the unit remains in MOIST MODE for about 3 seconds or more while you are cycling through the modes, Humidifying operation will be "ON".
- If  is pressed during AUTO operation or MOIST MODE, humidification will continue to be "ON" and AUTO FAN MODE will be set.

Operation

MODE	Usage and Function
<p>AUTO FAN</p>	<p>Automatic airflow rate adjustment</p> <p>FAN setting (“Quiet”, “Low”, “Standard”, “High**”) is automatically adjusted according to the degree of air impurity and humidity (when the Humidifying operation is active). Purifying capacity increases as airflow rate rises. If the operating sound bothers you, the airflow rate range can be changed. (▶Page 31, 32)</p> <p>* The maximum airflow rate during AUTO FAN MODE is “High”, which is less powerful than “Turbo”.</p> <ul style="list-style-type: none"> • Press <input type="button" value="HUM"/> if you want to change the humidity level. • Degree of air impurity corresponds to the volume of dust and the intensity of odours in the ambient air.
<p>ECONO</p>	<p>Saving energy</p> <p>In Power saving mode within ECONO MODE, the FAN setting automatically switches between “Quiet” and “Low” only. Power consumption (*1) and operating sounds are reduced. If the air is clean and the set humidity level has been achieved (when the Humidifying operation is active), after about 5 minutes passes, Monitoring mode automatically activates. Recommended for use during sleep hours.</p> <p>*1 By comparison to AUTO FAN MODE (about 15.4Wh), power consumption in ECONO MODE (about 8.4Wh) is about 7.0Wh lower. Test conditions case in Japan: operation in 10m² area over 1 hour. Assuming 1 cigarette was smoked immediately after the unit was turned on.</p> <div style="display: flex; justify-content: space-between;"> <div data-bbox="347 987 655 1227" style="border: 1px solid black; padding: 5px;"> <p>Power saving mode</p> <p>The unit operates automatically with an airflow rate of “Quiet” and “Low”.</p> </div> <div data-bbox="667 987 959 1249" style="text-align: center;"> <p>If the air is clean and the set humidity has been reached for about 5 minutes...</p>  <p>If the humidity level falls, or dust or odours are detected...</p> </div> <div data-bbox="970 987 1458 1227" style="border: 1px solid black; padding: 5px;"> <p>Monitoring mode</p> <ul style="list-style-type: none"> • The fan starts and stops periodically, and dust, odour and humidity is checked. • Turn “Off” the following functions to further reduce power consumption. <p><input type="button" value="Streamer OFF"/> <input type="button" value="Humidification OFF"/> (*2)</p> <p><input type="button" value="Active plasma ion OFF"/></p> </div> </div> <p>*2 The humidifier lamp remains lit.</p> <ul style="list-style-type: none"> • Air purification and humidification capacity will be reduced as only “Quiet” and “Low” operation are used. • Since the air in the room is not drawn in while the fan is stopped, the sensitivity of the PM2.5 sensor, odour sensor, and humidity sensor will decrease. If you do not want the sensitivity of the sensors to be reduced, set Monitoring mode to “OFF”. (▶Page 31, 32) • Press <input type="button" value="HUM"/> if you want to change the humidity level.

MODE	Usage and Function										
<p>ANTI-POLLEN</p>	<p>Reducing pollen levels</p> <p>A gentle air current is created by switching every 5 minutes between the FAN setting “Standard” and “Low” so that pollen can be drawn in and caught before it reaches the floor.</p> <ul style="list-style-type: none"> Press HUM if you want to change the humidity level. 										
<p>MOIST</p>	<p>Combating dry throat and skin</p> <p>Humidity is automatically adjusted to be gentle on the throat and skin. If the operating sound bothers you, the airflow rate range can be changed. ▶Page 31, 32</p> <ul style="list-style-type: none"> As humidity is kept relatively high, if the temperature difference between outdoors and indoors is large, condensation may result. Humidity setting is set automatically. Target humidity cannot be changed. If HUM is pressed when MOIST MODE is active, MOIST MODE stops and AUTO FAN MODE is activated. <div data-bbox="911 689 1401 1003"> <p>■ Room conditions and target humidity</p> <table border="1"> <caption>Room conditions and target humidity</caption> <thead> <tr> <th>Room temperature (°C)</th> <th>Target humidity (%)</th> </tr> </thead> <tbody> <tr> <td>10</td> <td>70%</td> </tr> <tr> <td>20</td> <td>60%</td> </tr> <tr> <td>25</td> <td>50%</td> </tr> <tr> <td>30</td> <td>40%</td> </tr> </tbody> </table> </div>	Room temperature (°C)	Target humidity (%)	10	70%	20	60%	25	50%	30	40%
Room temperature (°C)	Target humidity (%)										
10	70%										
20	60%										
25	50%										
30	40%										
<p>CIRCULATOR</p>	<p>When you want to circulate the air in the room</p> <p>The air in the room is kept clean and local variations in temperature are suppressed. It is even more effective if the unit is installed opposite an air conditioner. The airflow rate is “High” for about 30 minutes after operation start, in order to circulate the air in the room. After that, any temperature change around the unit is detected, and the airflow rate is automatically adjusted. (There is no temperature adjustment function.)</p> <ul style="list-style-type: none"> If the indoor temperature is low, the airflow rate may not be “High”. (To suppress any feelings of coldness caused by air currents) 										

Advanced Settings

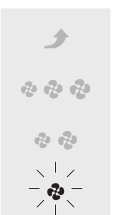
Function	1	
<p>Streamer Output Setting (Normal/Low) Settings at time of purchase: Normal</p> <p>If the hissing sound generated by the streamer discharge or the smell of ozone bother you, set it to "Low".</p> <ul style="list-style-type: none"> Setting to "Normal" is recommended, as deodorising capacity, etc. is reduced when set to "Low". 	<p>Setting can be performed either during operation or while operation is stopped.</p> <p>Press  for about 5 seconds, and when a short beep sounds, press  while continuing to hold down .</p> <p>When a short beep sounds, release  and .</p>	<p>The ANTI-POLLEN lamp blinks, then lights up.</p> <p> [Blinking → Lit up]</p> <p>According to the current setting, the FAN lamp will turn from blinking to lit up.</p> <p>  "Normal" "Low"</p>

2

Press  to change the setting*.

Each press cycles between "Normal" and "Low".

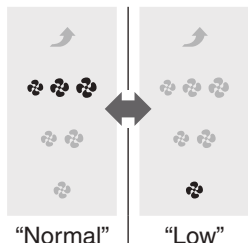

■ Operation status of streamer

Setting		Streamer output setting	
		Normal	Low
FAN	Quiet, Low	ON-OFF	OFF
	Standard	ON-OFF	
	Turbo	ON	
MODE	AUTO FAN/ ANTI-POLLEN/MOIST/ CIRCULATOR	ON-OFF	
	ECONO	ON-OFF	OFF
	AUTO operation	ON-OFF	

- The streamer operation status ON-OFF means that the streamer turns ON and OFF automatically depending on the degree of air impurity and airflow rate.

About the streamer lamp

- When the setting condition of streamer is "ON-OFF" or "ON", it is always lit up. (However, it is unlit during monitor mode) It is unlit when the setting condition of streamer is "OFF".

3

Press  .

A short beep sounds and the ANTI-POLLEN lamp and set FAN lamp will blink.



[Blinking]

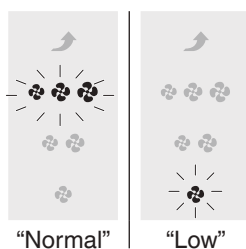

4

While the lamp is blinking, unplug the power supply plug, wait at least 5 seconds, and then insert the power supply plug again.



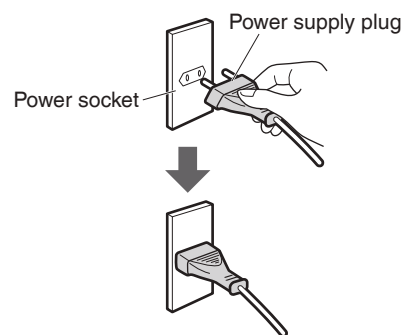







Setting is now complete.



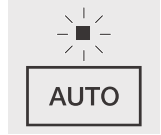
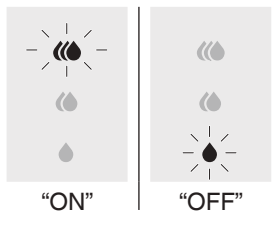



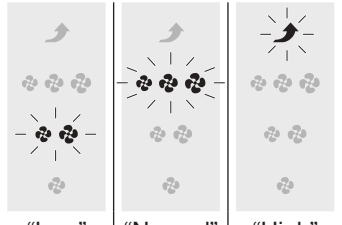

- If this procedure is not performed, the unit will not return to regular operation mode.
- The settings will be remembered even if the power supply plug is removed.

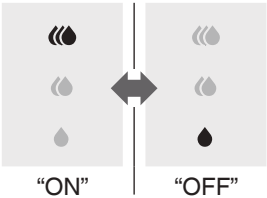
* If the lamps do not change even after the settings were changed, unplug the unit, wait at least 5 seconds, then re-insert the power supply plug and repeat the above procedure from the beginning.

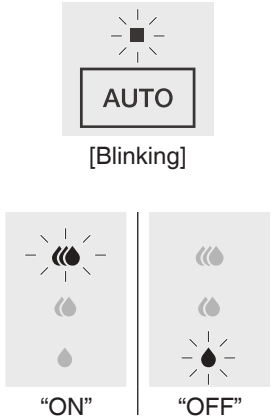
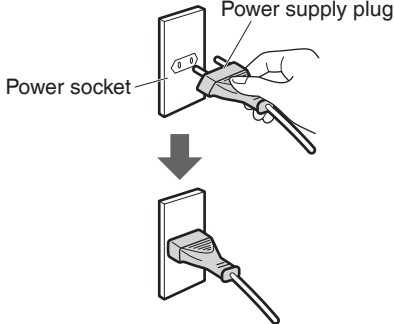

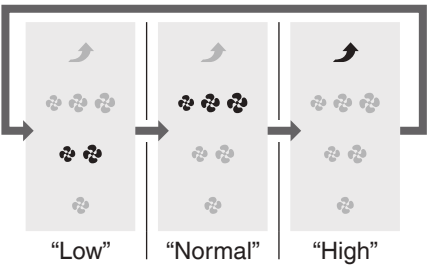

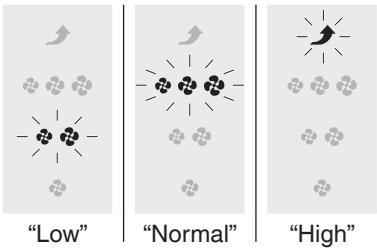







Advanced Settings





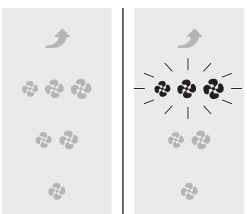

Function	1	
<p>Active Plasma Ion Output Setting (ON/OFF)</p> <p>Setting at the time of purchase: ON</p> <p>If the odour of ozone bothers you, set active plasma ion output to “OFF”.</p> <ul style="list-style-type: none"> • If set to “OFF”, active plasma ion discharge stops, however, dust and odour removal continues. • If the odour of ozone continues to bother you even after output has been set to “OFF”, set streamer output to “Low”. 	<p>Setting can be performed either during operation or while operation is stopped.</p> <p>Press  for about 5 seconds, and when a short beep sounds, press  while continuing to hold down .</p> <p>When a short beep sounds, release  and .</p>	<p>The AUTO operation lamp blinks, then lights up.</p>  <p>[Blinking → Lit up]</p> <p>According to the current setting, the Humidity setting lamp will turn from blinking to lit up.</p>  <p>“ON” “OFF”</p>
<p>PM2.5 sensor Sensitivity Setting (Low/Normal/High)</p> <p>Setting at time of purchase: Normal</p> <p>The sensitivity setting of the PM2.5 sensor can be set to “Low/Normal/High”.</p> <ul style="list-style-type: none"> • “Low” makes the sensor less responsive, and “High” makes the sensor more responsive. 	<p>Setting can be performed either during operation or while operation is stopped.</p> <p>Press  for about 5 seconds, and when a short beep sounds, press  while continuing to hold down .</p> <p>When a short beep sounds, release  and .</p>	<p>According to the current setting, the FAN lamp will turn from blinking to lit up.</p>  <p>“Low” “Normal” “High”</p>

2	3	4
<p>Press  to change the setting*.</p> <p>Each press cycles between "ON" and "OFF".</p> 	<p>Press  .</p> <p>A short beep sounds, the AUTO operation lamp blinks, and the set Humidity setting lamp will blink.</p> 	<p>While the lamp is blinking, unplug the power supply plug, wait at least 5 seconds, and then insert the power supply plug again. Setting is now complete.</p> 
<p>Press  to change the setting*.</p> <p>Each press cycles between "Low", "Normal" and "High".</p> 	<p>Press  .</p> <p>A short beep sounds, and the set FAN lamp will blink.</p> 	<ul style="list-style-type: none"> • If this procedure is not performed, the unit will not return to regular operation mode. • The settings will be remembered even if the power supply plug is removed.

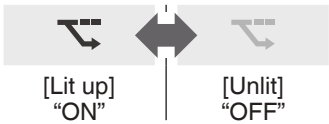
* If the lamps do not change even after the settings were changed, unplug the unit, wait at least 5 seconds, then re-insert the power supply plug and repeat the above procedure from the beginning.

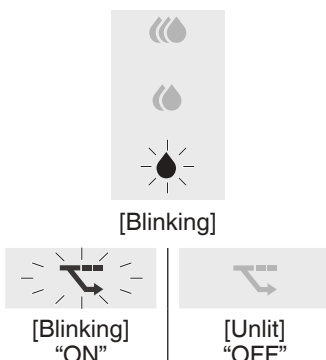
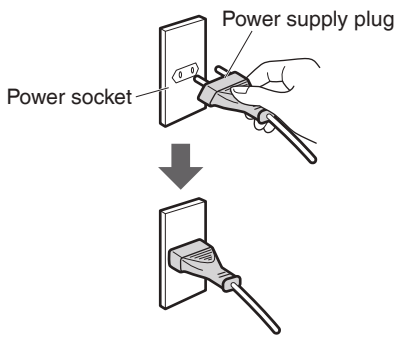
Advanced Settings

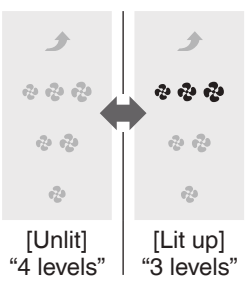

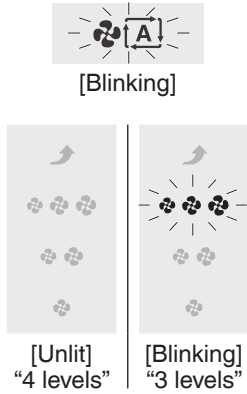

Function	1	
<p>Monitoring mode within AUTO Operation and ECONO MODE (ON/OFF) Setting at the time of purchase: ON</p> <p>The sensitivity of the sensors decrease while the fan is stopped during Monitoring mode. If you do not want the sensitivity of the sensors to be decreased, set to "OFF".</p> <ul style="list-style-type: none"> When set to "OFF", Monitoring mode will not be performed. 	<p>Setting can be performed either during operation or while operation is stopped.</p> <p>Press  for about 5 seconds, and when a short beep sounds, press  while continuing to hold down .</p> <p>When a short beep sounds, release  and .</p>	<p>The humidity setting lamps (Low) blinks, then lights up.</p>  <p>[Blinking → Lit up]</p> <p>According to the current setting, the ECONO MODE lamp will be displayed as follows.</p>  <p>[Blinking → Lit up] "ON" [Unlit] "OFF"</p>
<p>Airflow rate range for AUTO FAN (4 levels/3 levels) Setting at the time of purchase: 4 levels</p> <p>If you are concerned about the operation noise during AUTO FAN MODE/MOIST MODE/AUTO Operation, switch from "4 levels" to "3 levels".</p> <ul style="list-style-type: none"> Airflow rate range <ul style="list-style-type: none"> 4 levels: "Quiet" "Low" "Standard" "High" 3 levels: "Quiet" "Low" "Standard" 	<p>Setting can be performed either during operation or while operation is stopped.</p> <p>Press  for about 5 seconds, and when a short beep sounds, press  while continuing to hold down .</p> <p>When a short beep sounds, release  and .</p>	<p>The AUTO FAN MODE lamp blinks, then lights up.</p>  <p>[Blinking → Lit up]</p> <p>According to the current setting, the FAN lamp will be displayed as follows.</p>  <p>[Unlit] "4 levels" [Blinking → Lit up] "3 levels"</p>

2	3	4
<p>Press  to change the setting*.</p> <p>Each press cycles between "ON" and "OFF".</p> 	<p>Press  .</p> <p>A short beep sounds, the Humidity setting lamps (Low) blinks, and the ECONO MODE lamp changes to the following display according to the setting.</p> 	<p>While the lamp is blinking, unplug the power supply plug, wait at least 5 seconds, and then insert the power supply plug again. Setting is now complete.</p>  <ul style="list-style-type: none"> • If this procedure is not performed, the unit will not return to regular operation mode. • The settings will be remembered even if the power supply plug is removed.
<p>Press  to change the setting*.</p> <p>The airflow rate switches between "4 levels" and "3 levels" with each press.</p> 	<p>Press  .</p> <p>A short beep sounds, the AUTO FAN MODE lamp blinks, and the FAN lamp changes to the following display according to the setting.</p> 	

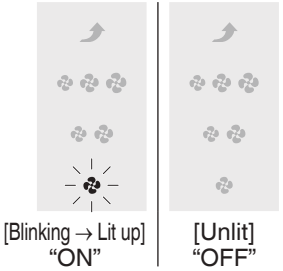
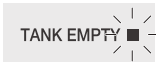
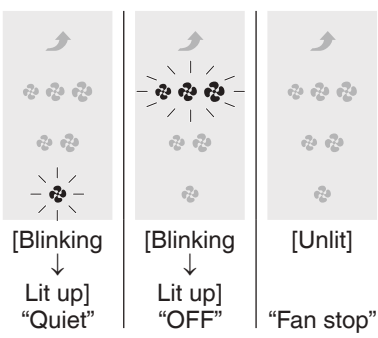
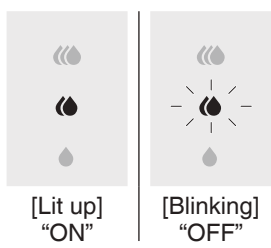
* If the lamps do not change even after the settings were changed, unplug the unit, wait at least 5 seconds, then re-insert the power supply plug and repeat the above procedure from the beginning.

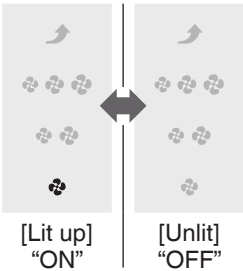
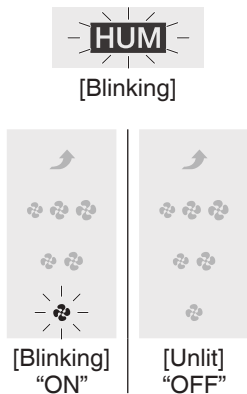
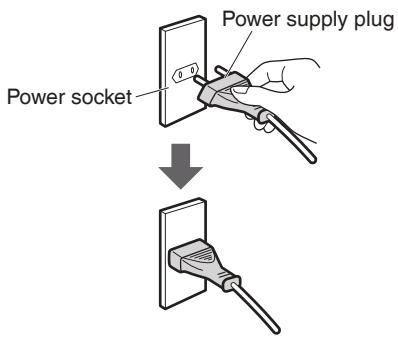
Advanced Settings

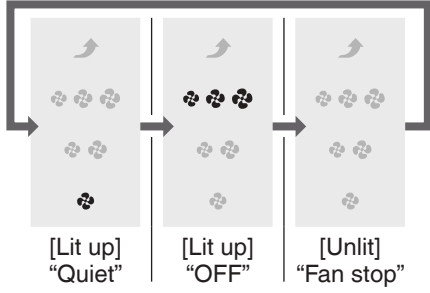
Function	1	
<p>Humidifying Filter Drying Operation (ON/OFF)</p> <p>Setting at the time of purchase: ON</p> <p>Humidifying filter drying operation is automatically started when operation is stopped after Humidifying Operation is performed in AUTO Operation, MODE operation, or Humidifying and Air Purifying Operation. (This shortens the period when the humidifying filters are left semi-damp and bacteria is likely to propagate.)</p> <ul style="list-style-type: none"> When set to "OFF", Humidifying Filter Drying Operation will not be performed. 	<p>Setting can be performed either during operation or while operation is stopped.</p> <p>Press MODE for about 5 seconds, and when a short beep sounds, press HUM while continuing to hold down MODE.</p> <p>When a short beep sounds, release MODE and HUM.</p>	<p>The humidifier lamp blinks, then lights up.</p>  <p>[Blinking → Lit up]</p> <p>According to the current setting, the FAN lamp will be displayed as follows.</p>  <p>[Blinking → Lit up] "ON" [Unlit] "OFF"</p>
<p>Airflow rate limit when the water supply lamp is lit (Quiet/OFF/Fan stop)</p> <p>Setting at the time of purchase: Quiet</p> <p>If you do not want the airflow rate set to "Quiet" when the water supply lamp is lit, set it to "OFF". When set to "OFF", even if the water supply lamp lights up, the airflow rate from before the lamp lit up continues. If you are concerned about the odour when the water supply lamp is lit, set to "Fan stop".</p>	<p>Setting can be performed either during operation or while operation is stopped.</p> <p>Press Power for about 5 seconds, and when a short beep sounds, press ON/OFF while continuing to hold down Power.</p> <p>When a short beep sounds, release Power and ON/OFF.</p>	<p>The water supply lamp blinks, then lights up.</p>  <p>[Blinking → Lit up]</p> <p>According to the current setting, the FAN lamp will be displayed as follows.</p>  <p>[Blinking → Lit up] "Quiet" [Blinking → Lit up] "OFF" [Unlit] "Fan stop"</p>
<p>Notification tone when water supply lamp is lit (ON/OFF)</p> <p>Setting at the time of purchase: ON</p> <p>If the notification tone emitted when the water supply lamp is lit bothers you, set it to "OFF".</p> <ul style="list-style-type: none"> This is a useful function during sleep hours. The error notification alarm cannot be turned off. 	<p>Press HUM for about 3 seconds while operation is stopped.</p>	<p>Each time HUM is pressed for about 3 seconds, the setting changes.</p>  <p>[Lit up] "ON" [Blinking] "OFF"</p>

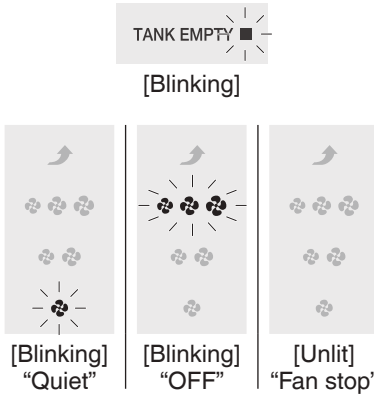
2	3	4
<p>Press MODE to change the setting*.</p> <p>Each press cycles between "ON" and "OFF".</p>  <p>[Lit up] "ON" [Unlit] "OFF"</p>	<p>Press HUM.</p> <p>A short beep sounds, the humidifier lamp blinks, and the FAN lamp changes to the following display according to the setting.</p>  <p>[Blinking] "HUM"</p> <p>[Blinking] "ON" [Unlit] "OFF"</p>	<p>While the lamp is blinking, unplug the power supply plug, wait at least 5 seconds, and then insert the power supply plug again.</p> <p>Setting is now complete.</p>  <p>Power supply plug</p> <p>Power socket</p>
<p>Press  to change the setting*.</p> <p>Each press cycles between "Quiet", "OFF" and "Fan stop".</p>  <p>[Lit up] "Quiet" [Lit up] "OFF" [Unlit] "Fan stop"</p>	<p>Press .</p> <p>A short beep sounds, the water supply lamp blinks, and the FAN lamp changes to the following display according to the setting.</p>  <p>[Blinking] "TANK EMPTY"</p> <p>[Blinking] "Quiet" [Blinking] "OFF" [Unlit] "Fan stop"</p>	<ul style="list-style-type: none"> • If this procedure is not performed, the unit will not return to regular operation mode. • The settings will be remembered even if the power supply plug is removed.
		<p>The setting is complete when it blinks or lights up for about 5 seconds and then turns off.</p>

* If the lamps do not change even after the settings were changed, unplug the unit, wait at least 5 seconds, then re-insert the power supply plug and repeat the above procedure from the beginning.

⚠ WARNING

- Be sure to stop operation and unplug the power supply plug before performing maintenance. (An electric shock or injury may result)

Maintenance

Maintenance Quick Reference Table

Check the reference pages for details on removing and attaching parts during cleaning/maintenance.

Unit

When dirt becomes an issue **Wipe**

- Wipe up dirt with a soft damp cloth.
- When dirt buildup is severe, wipe up the dirt with a cloth which has been moistened with kitchen-use neutral detergent.
- Do not use a hard brush, etc. (Damage may result)

PM2.5 sensor

When dust has built up

Vacuum cleaner

- ① Remove the pre-filter (right-side).
- ② Vacuum off any dust using a vacuum cleaner crevice tool or similar.

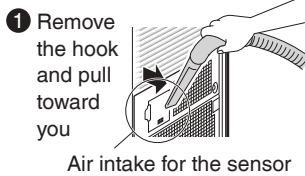

About every 3 months **Wipe**

- ② Remove the pre-filter (right-side) and the cover of the air intake for the sensor.

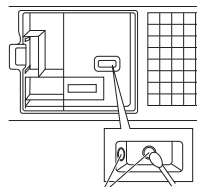

- Vacuum off any dust around the area using a vacuum cleaner crevice tool or similar.
- Clean the lenses with a wet baby cotton bud softly and then remove the water with a **dry baby cotton bud**.
- Do not use alcohol for cleaning.

- ③ Lens (2 places)

- ④ After cleaning, be sure to attach the cover securely. (Malfunction may result)

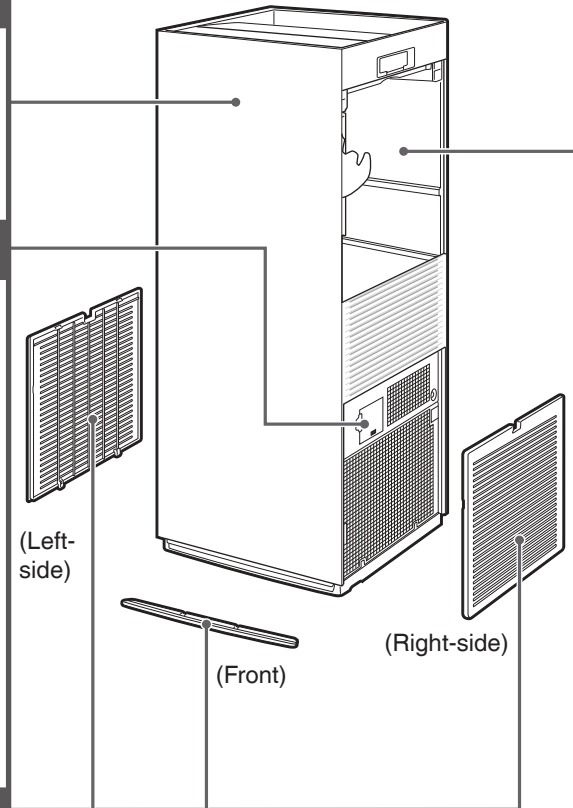

Pre-filter (Front/Left-side/Right-side)

About 1 time every 2 weeks

Vacuum cleaner

Wash/Rinse

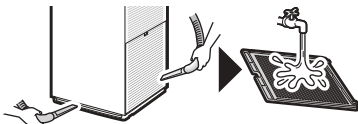

- After removing any dust using a vacuum cleaner, remove and wash the filter with water, then dry thoroughly in the shade.
- Use a soft brush when cleaning the spaces in the grid.

Attention

- **Do not use a cotton bud or hard brush.** (Partial damage to the filter may result)
- **Do not apply too much force.** (Partial damage to the filter and scratching may result)
- When dirt buildup is severe, leave the part soaking in lukewarm or room temperature water mixed with kitchen-use neutral detergent, thoroughly rinse off the detergent and leave the part in shade to dry off.

How to remove

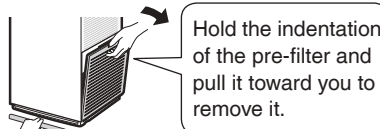

- ① Hold down the upper centre of the pre-filter with a finger to release the hooks.
- ② Pull it toward you to remove it.

How to attach

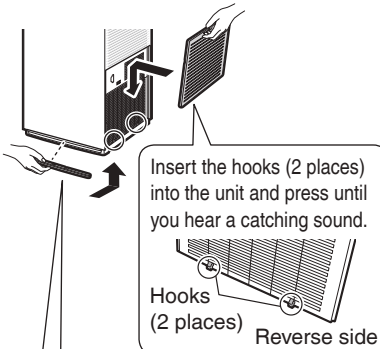

Push all the way in and insert the hook (1 place) in the centre upward to attach it to the unit.

Hook (1 place)



Attention

- Observe in order to prevent discolouration or deformation.
 - If detergent was used, wipe thoroughly so that no detergent remains.
 - When using hot water, keep the temperature below 40°C.
 - Do not dry in direct sunlight.
 - Do not dry with a hairdryer.
 - Do not expose to fire.
- When using a vacuum cleaner, do not impact the part with the vacuum cleaner. (Scratching may result)
- Do not use flammable sprays (hair spray, insecticides, disinfectants, air dusters, etc.) or deodorisers near or directly on the unit. (Do not use such articles where there is a risk of suction into the unit)
- This air purifier is a device which gathers all the dust and odour throughout an entire room. If used in an environment with strong odours such as aromatic substances, aroma oils, cigarettes or roasted meat, odours may adhere to the filter, causing the re-emission of such odours for a few weeks to a few months. If using in an environment with strong odours, ventilating the room while using the air purifier is recommended. (The time required to remove odour is longer than the time required to remove dust)

! WARNING

- Do not use petrol, benzene, thinner, polishing powder, paraffin, alcohol, etc. (Cracking, electric shock, and ignition of fire may result)
- Do not wash the unit with water. (An electric shock and fire or malfunctioning may result)

Water tank For details on removal and attachment, refer to ▶Page 17

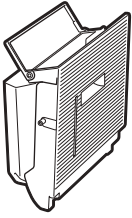

Inside the water tank

Every day for Humidifying Operation

Wash/Rinse

▶Page 37, 38

Water tank surface

When dirt on the surface becomes an issue

Wipe

- Wipe up dirt with a soft damp cloth.
- If dirt buildup is severe, wet a cloth with kitchen-use neutral detergent and wipe up the dirt, and then thoroughly rinse off the detergent so that no detergent remains.

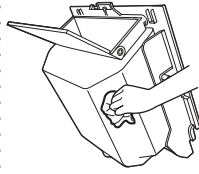

Humidifying filter unit For details on maintenance and removal/attachment, refer to ▶Page 39-41



About every 1 week

Soak

About every 1 month or when smell, dirt, or water scales (white and brown) become an issue

Soak in baking soda, citric acid or lemon juice

About every 10 years

Replace

▶Page 42

Humidifying tray For details on maintenance and removal/attachment, refer to ▶Page 39

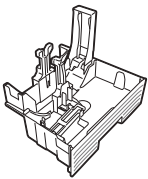

About every 3 days or when odour or dirt becomes an issue

Wash/Rinse

Filter fixing unit For details on removal and attachment, refer to ▶Page 15

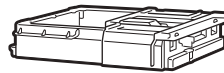

When dirt becomes an issue

Vacuum cleaner

- Remove, then vacuum away dust using a vacuum cleaner.

Deodorising filter For details on removal and attachment, refer to ▶Page 14, 15

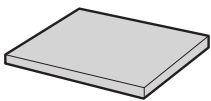

When dirt becomes an issue

Vacuum cleaner

Cannot be washed with water

- Remove, then vacuum away dust using a vacuum cleaner.
- When odour becomes an issue, leave the part in a shaded area exposed to the breeze. (about 1 day)
- Do not scrub the surface.
- Do not use water when cleaning. (If water is used, the part will lose its shape and become unusable.) ▶Page 45

When odour becomes an issue

Leave in a breezy, shaded area

The surface may appear partially white, but there is no problem with deodorising performance and use. Because dust from the deodorising filter may make your hands dirty, wear gloves.

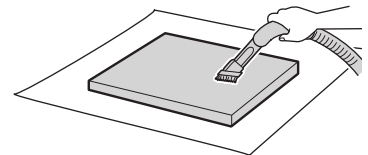

Dust collection filter For details on removal and attachment, refer to ▶Page 43

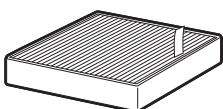

When dirt becomes an issue

Vacuum cleaner

Cannot be washed with water

- Lightly vacuum the dust on the surface that doesn't have the tag. (Be careful as the filter is easily damaged.)

If you lay down newspaper etc., the surroundings will not get dirty



About every 10 years

Replace

▶Page 43

If the filter is damaged or holes are opened etc., dust will pass through the filter and capacity for dust collection will be reduced.

Maintenance

Water tank Wash/Rinse

Inside the water tank Every day for Humidifying Operation

CAUTION

If the water tank lid was removed when cleaning, check that the rubber packing is properly attached to the lid. Attach the water tank to the unit with the lid securely attached to the water tank.

(If the water tank is attached to the unit without the lid attached, it may close vigorously and pinch your fingers)

- Clean the water tank by shaking a small amount of water inside with the lid of the water inlet closed. After washing, remove the lid of the water tank before discarding the water.
- For areas with water scales, remove the water scales with a soft cloth or brush or cotton bud soaked in lukewarm or room temperature water in which citric acid has been dissolved.
(From the bottom of the water tank, push the valve part up and check the gap around the valve, too)
Finally, rinse with water.

- If dirt is difficult to remove, clean with a soft brush or diluted kitchen-use neutral detergent and thoroughly rinse off the detergent so that no detergent remains. If dirt has built-up in the metal filter of the water tank lid, remove it with a soft brush.
- From the bottom of the water tank, push the valve part up and check that the valve moves smoothly.
- Do not apply excessive force when cleaning.
(Damage or deformation of the metal filter may result)

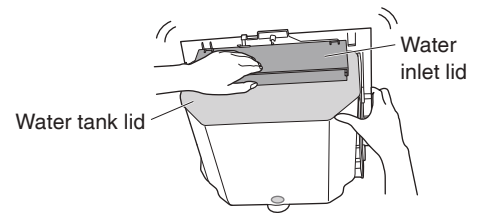
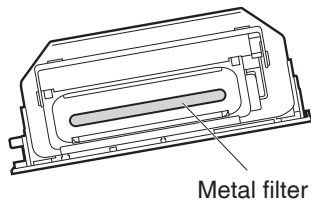

Attention

Be careful not to push the metal filter from the reverse side while cleaning etc., as it may become detached.

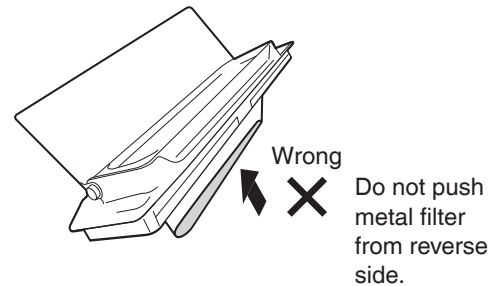

If the metal filter becomes detached, reattach it in accordance with "If metal filter detaches from water tank lid". [▶Page 38](#)

- If dirt is trapped in the valve inside the water tank, remove it with a cotton bud.
(If dust is trapped, it may cause water leakage)
After cleaning, fill the water tank with water and let it sit for a while (about 30 seconds) to ensure there is no water leakage from the bottom of the tank.

Attention

Please heed the following 2 precautions when cleaning the valve to reduce the risk of water leakage:

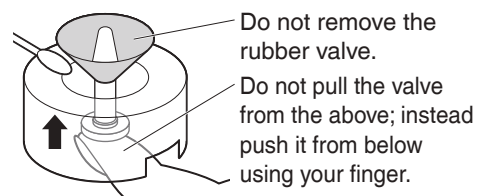

If the valve becomes detached, reattach it in accordance with "If valve becomes detached from the water tank". [▶Page 38](#)

⚠ WARNING

Be sure to stop operation and unplug the power supply plug before performing maintenance. (An electric shock or injury may result)

How to remove the lid

1. Bend the tank cover and release the hooks (2 places) securing the lid.
2. Lift the lid up toward you to remove it.
 - Make sure to hold the water tank firmly.

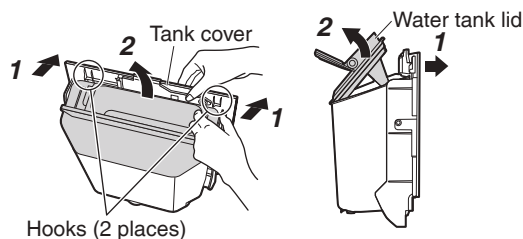

How to attach the lid

1. Push the front of the lid. (2 places)
2. Push the back of the lid (2 places) and secure it to the hooks.

- Make sure that the water tank lid is securely attached.
- Do not operate the unit without the water tank lid attached. (May prevent water tank being attached to unit, or water leakage may result)

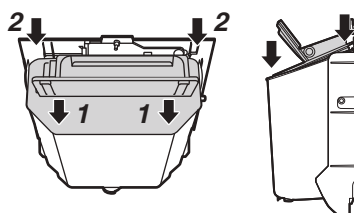

How to remove the rubber packing

- Remove the rubber packing from the recess on the back side of the lid.
- Attach in the reverse order.
- After installing, run your hands around the perimeter to check that there is no twisting or loosening and that it is firmly fitted in the recessed part.

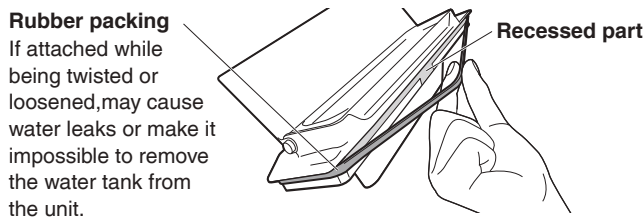

If metal filter detaches from water tank lid

- ① Put on gloves. (Rim of the metal filter could cut your hand)
- ② Attach the metal filter from the top of the water tank lid.

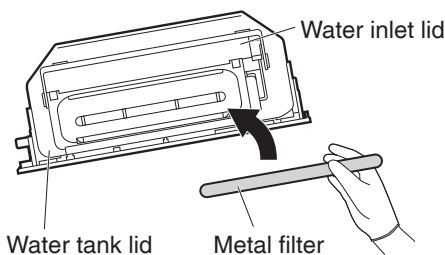

- ③ Affix it to the hooks (8 places) using a rod-shaped object with a blunt tip. (Deformation of the metal filter may result if a sharp object is used.)

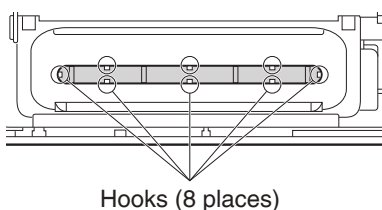

If valve becomes detached from the water tank

- ① Attach the spring to the valve rod. (Be careful not to lose the spring.)
- ② Insert the valve rod into the hole in the base of the water tank from the outside.

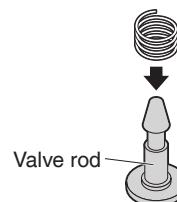

- ③ Slot the rubber valve on to the inserted valve rod.
- ④ Turn the valve about half a turn while pushing the valve rod from below and check that the rubber valve moves smoothly alone (and not with the valve rod). If it does not turn smoothly, there is a chance that the valve is out of place.

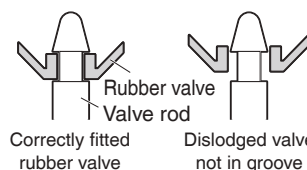
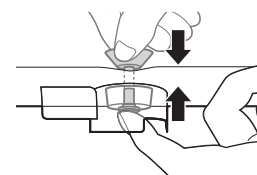
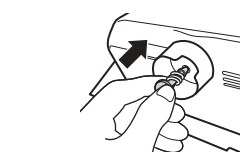

- ⑤ After attaching the valve, fill the water tank with water and let it sit for a while (about 30 seconds) to ensure there is no water leakage from the bottom of the tank.

Maintenance

When dirty, the humidifying tray and humidifying filters may emit bad odours. Be sure to clean them periodically.

How to remove the humidifying tray and humidifying filter unit

1. Remove the water tank. [▶Page 17](#)
2. Pull out the humidifying tray and remove humidifying filter unit.

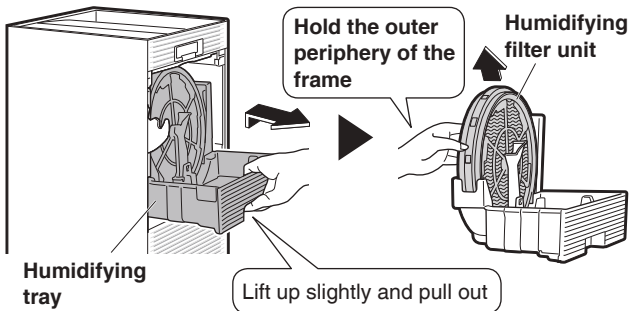

- If there is water inside, the water surface may shake and spill, so pull it out slowly.
- When carrying, hold the base of the humidifying tray.

How to attach the humidifying tray and humidifying filter unit

1. Attach the humidifying tray and humidifying filter unit.

① Attach the humidifying filter unit

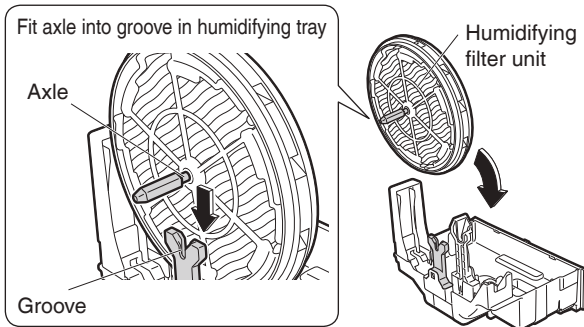

② Push the humidifying tray all the way in

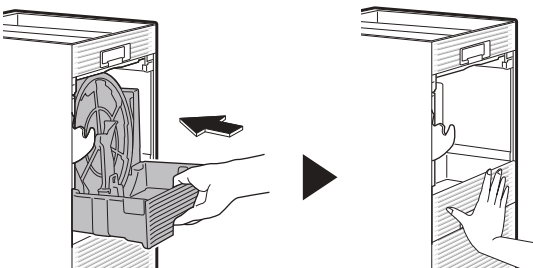

- If the humidifying filter unit is not properly attached to the humidifying tray, the humidifying tray cannot be attached to the unit.

Attention

After attaching the humidifying tray to the unit, do not forcibly rotate the humidifying filter unit. Malfunction may result.

Humidifying tray Wash/Rinse

About every 3 days or when odour or dirt becomes an issue, clean with water.

- Use a soft cloth, brush, or cotton bud to clean hard-to-reach places.
- For areas with water scales, remove the water scales with a soft cloth or brush or cotton bud soaked in lukewarm or room temperature water in which citric acid has been dissolved.

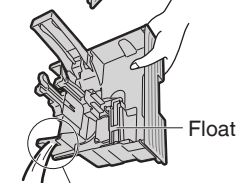
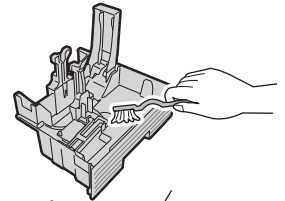

Discard the residual water in the tray from here

When removing water

scales, be careful not to get the silver ion cartridge wet. (The antibacterial effect may decrease.)

- (Lift up the float and check that there are no water scales under the float)
- Finally, rinse with water.
- Citric acid may be purchased at a pharmacy or drug store or super market.

Note

- Depending on water quality and the usage environment, water in the humidifying tray may become discoloured due to water scales etc. Clean it also in such cases.
- Make sure that the float is not stuck in water scales. (Water leakage may result if the float is stuck)

Attention

Silver ion cartridge

- Do not remove.
- Do not clean with baking soda or citric acid. Loss of the capacity for slime-resistance will result.

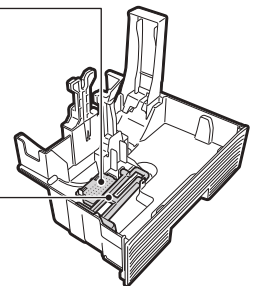

Float

- Do not remove. Humidifying Operation will become impossible.

If the float is detached from the tray

Insert the axle into the hole of the tray

- Make sure the float is placed below the tray protrusion.

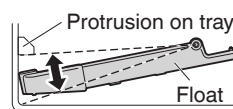

Sectional view

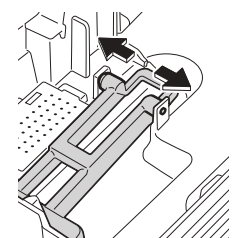

- Pour water into the tray and check that the float rises.
- After checking, be sure to discard the water, then attach the humidifying tray to the unit.

2. Install the water tank. [▶Page 17](#)

WARNING

Be sure to stop operation and unplug the power supply plug before performing maintenance. (An electric shock or injury may result)

Humidifying Filter Unit Soak in baking soda, citric acid or lemon juice

About every 1 week

Clean by soaking in lukewarm (about 40°C or less) or room temperature water.

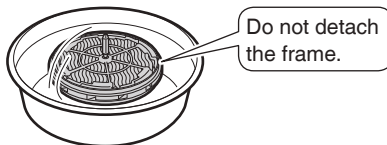

About every 1 month or when smell, dirt, or water scales (white and brown) become an issue

If water scales are not removed and the unit continues to be operated, reduced humidifying capacity and water leakage may result.

Symptom	If odour becomes an issue		If dirt becomes an issue
		Sour odour	An odour like aromatic substances or old rags
Maintenance method	Soak with baking soda	Soak with citric acid or lemon juice	
If odour cannot be removed even after cleaning...	Soak with citric acid	Soak with baking soda	—

* If odour and dirt are still an issue, clean with **neutral detergent**.

If you are concerned about odour during humidifying filter drying operation or when the water supply lamp is lit, set humidifying filter drying operation to "OFF" or the airflow rate limit when the water supply lamp is lit to "Fan stop". (▶Page 33, 34)

Example of sour odours

Damp laundry odour, dust odour, foot odours, rotten egg odours, rotting garbage odour, cheese odour, hospital odour, fermented odour

Examples of odours such as rags

Fishy odour, rotten fish odour, mouldy water odour, old book odour, mould odour

Maintenance with baking soda method

- Soak the parts for about 30 to 60 minutes in lukewarm (about 40°C or less) or room temperature water mixed with baking soda. After soaking, rinse with water.

Usage quantity:
2 tablespoons of baking soda in 1L of water

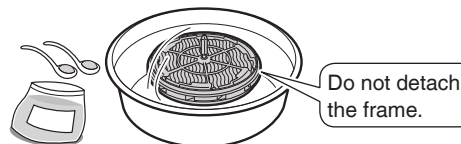

Maintenance with citric acid method or lemon juice

Soak in lukewarm (about 40°C or less) or room temperature water mixed with citric acid or lemon juice for about 2 hours. After soaking, rinse with water.

- If dirt buildup is an issue, extend the soaking time.

Usage quantities for citric acid:
approx. 20g of citric acid (2 tablespoons) in 3L of water

- Citric acid may be purchased at a pharmacy, drug store or super market.



Usage quantities for lemon juice:
1/4 cup of lemon juice per 3 cups of water

- Bottled 100% lemon juice can be used. Use only 100% lemon juice with no pulp (strain juice if necessary).
- If you squeeze a lemon, make sure there are no pieces of peel or pips.

Maintenance with neutral detergent method

- Soak the parts for about 30 to 60 minutes in lukewarm (about 40°C or less) or room temperature water mixed with kitchen-use neutral detergent. After soaking, rinse with water.

Usage quantity:
The quantity indicated in the directions on the detergent



Soak in lukewarm (about 40°C or less) or room temperature water for an additional 1 hour.

- When areas with dirt become an issue, clean by scrubbing gently with a soft sponge or cotton bud.

Maintenance

Humidifying Filter Unit Soak in baking soda, citric acid or lemon juice

Precautions when cleaning humidifying filter unit

- Do not mix baking soda with citric acid or lemon juice when cleaning.
- Do not apply force when cleaning the humidifying filter unit.
Do not use a brush or scrub forcibly.
(Deformation may result)
- Clean the frame of the humidifying filter unit with a soft cloth, brush, or cotton bud.
(For details on removal/attachment of the humidifying filter unit frame, refer to [▶Page 42](#).)
- To prevent bad odours and discolouration, be sure to thoroughly rinse off the parts with clean water.
(Even if discolouration results, it is not a problem for use)

The cause may be the odour of the deodorising filter or dust collection filter.

Try cleaning the filters. [▶Page 36](#)

Attention

- If cleaned with baking soda or neutral detergent, the antibacterial effect may decrease.
- The parts can be used even if still wet after cleaning.
- If not to be used for a prolonged period, leave the parts in a shaded area to dry off thoroughly, then attach.
- Dirt buildup varies by the usage environment of the humidifying filters.
It is recommended that you clean the parts if you notice an odour from the air outlet or a reduction in humidifying capacity (water usage rate).

When dirt inside the unit is an issue

When the water tank is removed, you may find that the inside of the unit is stained white. These are water scales caused by dirt in the water which adhered when the water vaporised, and they are not a problem.

If the stains are an issue, they can be removed.

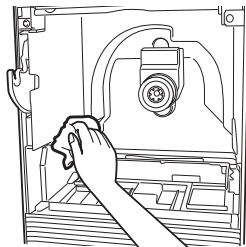

- Wipe up dirt with a soft damp cloth.
- When dirt buildup is severe, wipe up the dirt with a cloth which has been moistened with kitchen-use neutral detergent.
- Do not use a hard brush etc. (Damage may result)

⚠ WARNING

Be sure to stop operation and unplug the power supply plug before performing maintenance.
(An electric shock or injury may result)

Humidifying filters Replace

Replace about every 10 years*

About part replacement timing

- Replacement timing depends on usage patterns and the location of the unit.
Standard replacement time is about 10 years assuming that the filter is used 8 hours per day, 6 months per year, and is cleaned periodically.

Replace the humidifying filters if dirt/stains cannot be removed or there is a reduction in humidifying capacity (water usage rate).

About purchasing and disposal

- Refer to "Separately Sold Parts". ▶Page 56

Figure with humidifying filter unit disassembled

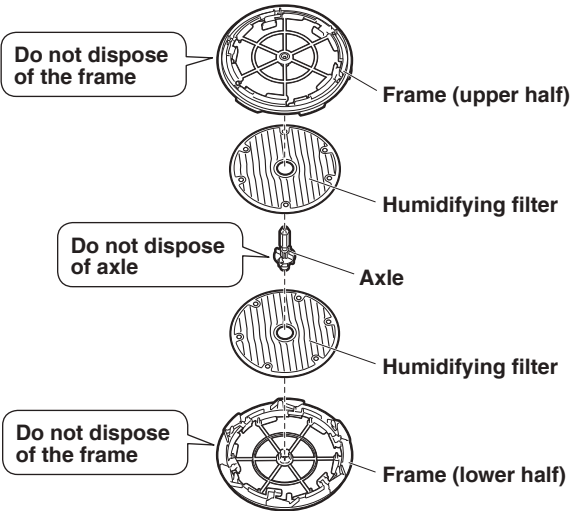

1. Remove the frame and axle.

- ① Release the frame hooks (6 places).

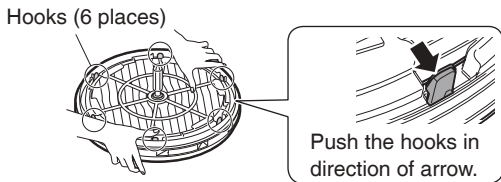

- ② Remove the frame (upper half) and pull out the axle from the frame (lower half).

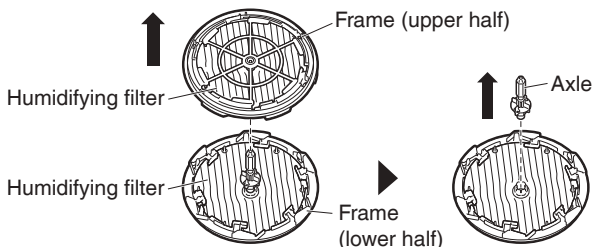

2. Remove the humidifying filters.

- Detach the humidifying filters from each frame.

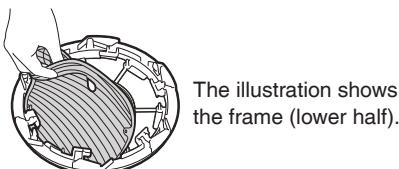

3. Attach new humidifying filters to each frame. (Both humidifying filters have a front and back.)

- Align the protrusions (6 places) on each frame with the holes (6 places) in the humidifying filter. (Water leakage may result if not correctly attached.)

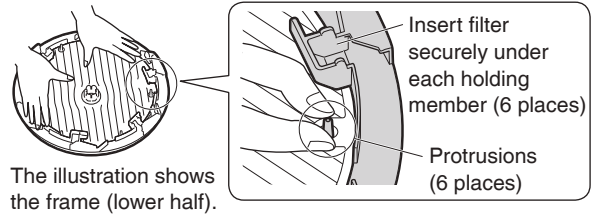

Filter and frame combinations

- Attach the filters to the frames so that the weaving pattern of each filter matches the makings on the frame.

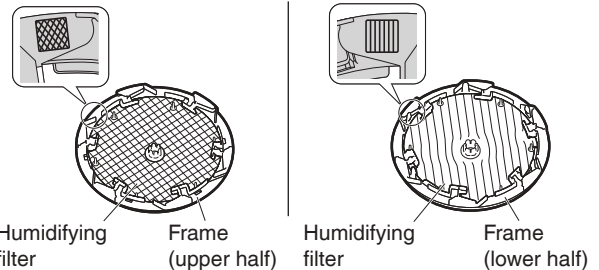

4. Attach the frames and axle.

- ① Align the grooves in the frames (upper half and lower half) with the projections on the axle when attaching.

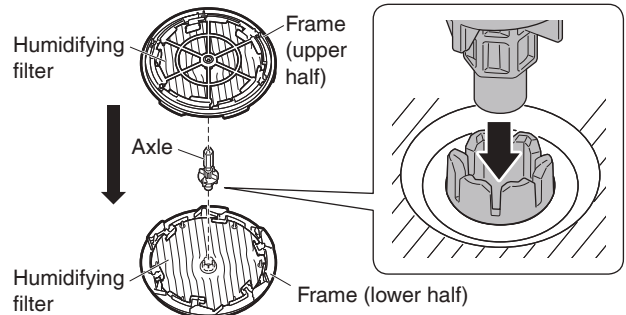

- ② Insert the hooks (6 places) until you hear a catching sound.

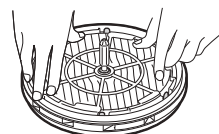

* Time until humidifying capacity drops to 50% of the rated humidifying capacity

Be sure to operate with the dust collection filter and deodorising filter attached. If the unit is operated without the filters attached, malfunction may result.

Maintenance

Dust collection filter Replace

Replace about every 10 years

About part replacement timing

- Replacement timing depends on usage patterns and the location of the unit.
Standard replacement time is about 10 years assuming that the unit is used daily in a home where 5 cigarettes are smoked a day. (Calculation in accordance with testing method of Japan Electrical Manufacturers' Association JEM1467 standard)
If the impurity content of the ambient air is high, the filter will need more frequent replacement.
If the filter is failing to perform, it is time to replace it.

About purchasing and disposal

→ Refer to "Separately Sold Parts". ▶Page 56

1. Remove the water tank. ▶Page 17

2. Remove the humidifying tray. ▶Page 15

3. Remove the filter fixing unit. ▶Page 15

4. Remove the deodorising filter.

Hold the side of the filter and remove it.

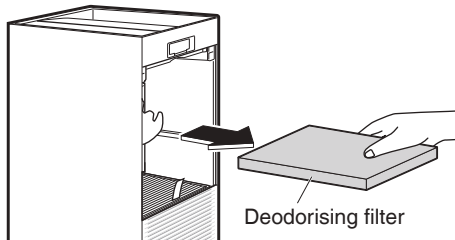

5. Remove the dust collection filter.

① Pull the filter tag upward.

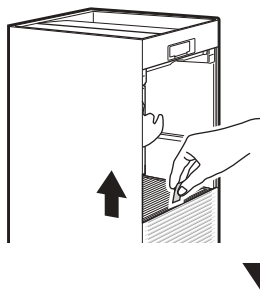

② Hold the lower part of the dust collection filter and lift it out.

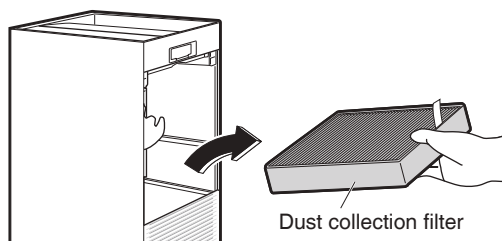

6. Attach a new dust collection filter.

- If it is hard to install, push the dust collection filter while installing.



7. Attach the deodorising filter. ▶Page 15

8. Attach the filter fixing unit. ▶Page 15

9. Attach the humidifying tray. ▶Page 39

10. Put the water tank in. ▶Page 17

—  **WARNING**

Be sure to stop operation and unplug the power supply plug before performing maintenance.
(An electric shock or injury may result)

When Not Using the Unit for a Prolonged Period

- 1. Unplug the power supply.**
- 2. Discard any residual water in the water tank and humidifying tray and then clean the parts.** ▶Page 35-41
- 3. Leave internal parts in a shaded area to dry off.**
 - In particular, parts cleaned with water should be completely dry.
(Mould may result from remaining moisture)
- 4. Cover the air outlet and other openings with a plastic bag or similar to prevent dust entry, and store the unit upright in a dry place.**
(Malfunction may result from storing the unit upside down or horizontally)

When not using Humidifying Operation (during the off-season etc.)

- 1. Unplug the power supply.**
- 2. Discard any residual water in the water tank and humidifying tray and then clean the parts.** ▶Page 35-41
- 3. Leave internal parts in a shaded area to dry off.**
 - In particular, parts cleaned with water should be completely dry.
(Mould may result from remaining moisture)

If you want to perform Air Purifying Operation only, insert the power supply plug into the power socket and operate.

FAQs

Please check first before contacting us.

Q: The value displayed as the PM2.5 concentration is always low and seems unresponsive, or the sensitivity of the PM2.5 sensor seems to be poor...

A: If the PM2.5 sensor lens is dirty, the sensitivity may become poor, so clean it regularly. (▶Page 35)
 In addition, the reaction time of the PM2.5 sensor varies depending on the size of the room.
 Adjust in accordance with the PM2.5 sensor Sensitivity Setting. (▶Page 29, 30)
 The responsiveness of the PM2.5 sensor may be poor when airflow rate is high such as “Turbo”.
 This is not a malfunction because the airflow rate is strong and the dust is sucked into the air inlet before it reaches the PM2.5 sensor.
 If the airflow rate limit when the water supply lamp is lit is set to “Fan stop”, the fan will stop when the water supply lamp is lit, and the PM2.5 sensor may not respond well. (▶Page 33, 34)

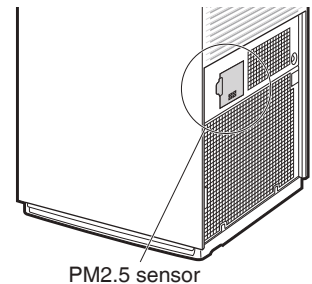

Q: Can the dust collection filter be cleaned with water?

A: It cannot be cleaned with water.
 (Reduced performance of the dust collection filter may result)
 Replace it or vacuum away dust with a vacuum cleaner if dirt buildup is severe. (▶Page 36, 43)
 Depending on the usage environment, odours may become adhered to the dust collection filter.
 If the odour bothers you, replace it. (▶Page 43)

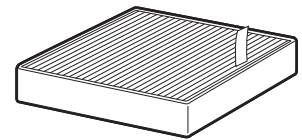

Q: The dust collection filter easily turns black...

A: The blackening does not affect dust collection performance. However, it can be replaced if it is an issue. (▶Page 43)

Q: Can the deodorising filter be cleaned with water? Or should it be replaced?

A: It cannot be cleaned with water.
 (If water is used, the part will lose its shape and become unusable.)
 If you have inadvertently washed it with water, contact the place of purchase.
 Remove from the unit and vacuum off dust with a vacuum cleaner. (▶Page 36)
 Also, it is not necessary to replace it.
 Depending on the usage environment, odours may become adhered to the deodorising filter.
If odour becomes an issue, leave the part in a shaded, breezy area. (about 1 day)

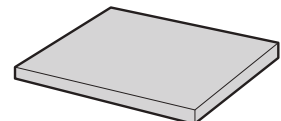

Q: No steam is visible during the Humidifying Operation...

A: No steam is visible because humidification is carried out by passing air through the humidifying filters and vaporizing, rather than by boiling water.

Q: Air emitted during the Humidifying Operation feels cool...

A: Emitted air is a little lower in temperature than the air drawn-in because heat in the air is consumed when the water contained in the humidifying filters is vaporized.

Q: Humidification is in progress but ambient humidity is not rising...

A: It may be difficult to raise the humidity depending on room size and conditions.
 Set the **humidity setting** to “ (High)” and increase the FAN setting before use.
 Dirt buildup on the humidifying filter unit can cause reduced performance. Clean it regularly. (▶Page 36, 39-41)

Q: Is it not necessary to replace the silver ion cartridge attached to the humidifying tray?

A: The silver ion cartridge has a service life of 10 years.

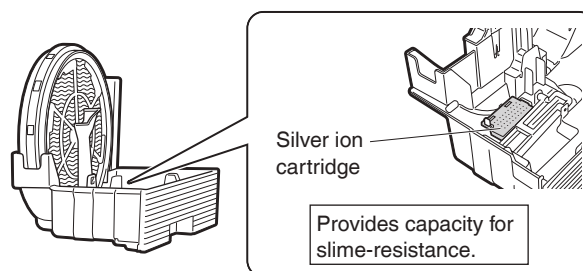

Q: The water tank cannot be removed smoothly...

A: It can be removed by releasing the side lock. [▶Page 17](#)

Q: Is continuous operation possible?

A: It can be operated continuously.
Stop operation regularly and clean it.

Q: Operation continues even though I try to stop it...

A: This is because humidifying filter drying operation is being carried out. [▶Page 24](#)

If you want to stop operation, press  .

States of the AIR MONITOR indicator and Their Meanings

If the AIR MONITOR indicator blinks and an error code appears, unplug the power supply plug, wait at least 5 seconds, and then reinsert the power supply plug and operate. If an error code still appears, handle it by following the setting procedure.

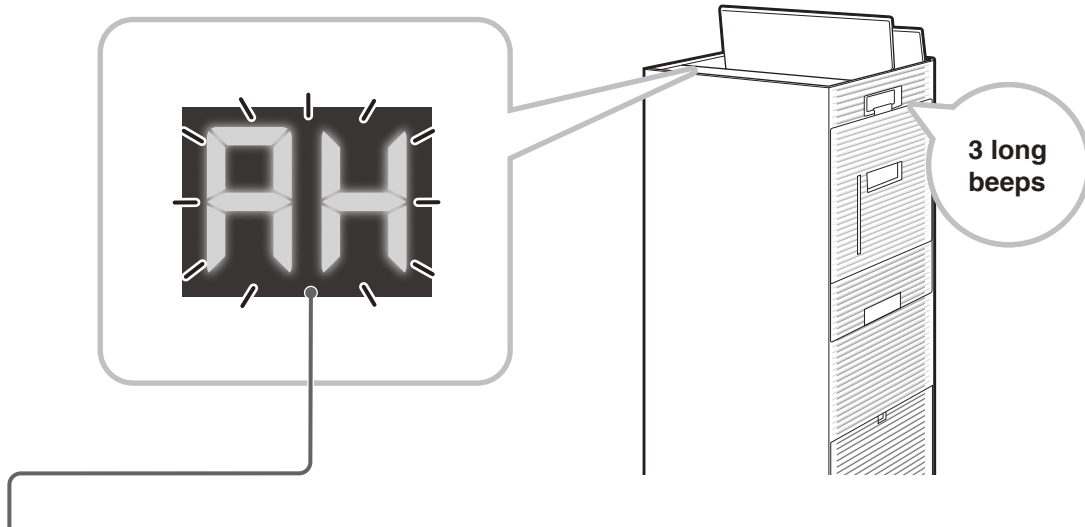

Error code	Cause/Solution	
AH	An electrical component is faulty. → Contact the place of purchase.	
E9	The temperature sensor is malfunctioning. → Contact the place of purchase.	
EE	The humidity sensor is malfunctioning. → Contact the place of purchase.	
A1	An electrical component is malfunctioning. → Contact the place of purchase.	
A6	Are the pre-filter, dust collection filter, humidifying filter unit, humidifying tray, and water tank attached? These lamps may blink if the unit is operated without a part attached.	<ul style="list-style-type: none"> ■ If all the parts are attached An electrical component is malfunctioning. → Contact the place of purchase. ■ If a part is not attached → Unplug the power supply plug, reattach the parts, and then restart operation.
	Is there a buildup of dust on the pre-filter?	<ul style="list-style-type: none"> ■ If there is no dust buildup An electrical component is malfunctioning. → Contact the place of purchase. ■ If there is dust buildup → Unplug the power supply plug, clean the pre-filter, and then restart operation. (▶Page 35)
	Is the air outlet blocked?	<ul style="list-style-type: none"> ■ If the air outlet is not blocked An electrical component is malfunctioning. → Contact the place of purchase.
		<ul style="list-style-type: none"> ■ If the air outlet is blocked → Remove any obstacles blocking the air outlet, and then restart operation.

Troubleshooting

- Before making an inquiry or a request for repair, please check the following.
If the problem persists, contact the place of purchase.



Not a problem

This case is not a problem.



Check

Please check again before requesting repairs.

■ Unit will not operate

Phenomenon	Check points
Unit will not operate	<ul style="list-style-type: none"> Is the streamer unit cover attached? If it is not attached the safety switch will engage, and the unit cannot operate. → Install the streamer unit cover properly and attempt operation again. (▶Page 8) Is the airflow rate limit when the water supply lamp is lit set to “Fan stop”? → If the airflow rate limit when the water supply lamp is lit is set to “Fan stop”, the fan will stop when the water supply lamp is lit. (▶Page 33, 34)

■ Operation continues













Phenomenon	Check points
Operation continues even though I try to stop it	<ul style="list-style-type: none"> This is because humidifying filter drying operation is being carried out. If you do not want to perform humidifying filter drying operation, change the setting. (▶Page 33, 34)

■ Sounds can be heard

Phenomenon	Check points
Catching sound during Humidifying Operation	<ul style="list-style-type: none"> A catching sound may be generated when Humidifying Operation starts/stops.
Sizzling or rumbling sounds after Humidifying Operation stops or during Humidifying Operation	<ul style="list-style-type: none"> These sounds are generated when the humidifying filter unit rotates. If the sounds are an issue, move the unit to a different location.
Creaking sound during Humidifying Operation	<ul style="list-style-type: none"> Is the humidifying tray or humidifying filter unit dirty? → A sound may be generated when there is a buildup of water scales on the humidifying tray or humidifying filter unit. Clean these parts. (▶Page 39-41)
Splashing sound during Humidifying Operation	<ul style="list-style-type: none"> This is the sound of water splashing on the humidifying filters.
Hissing sound during operation	<ul style="list-style-type: none"> A hissing sound is generated when there is streamer discharge during streamer operation. Depending on usage conditions, the sound may lessen or change to a crackling, whirring or guzzling sound. However, this is normal. If the sounds are an issue, move the unit to a different location. You can also set the streamer output to “Low”. (▶Page 27, 28)
Whistling and fluttering sound during operation	<ul style="list-style-type: none"> Is there a buildup of dust on the pre-filter? → Clean it. (▶Page 35) Is the dust collection filter clogged up? → Clean it. (▶Page 36) Depending on usage conditions, the dust collection filter may become clogged up, shortening its service life. (▶Page 7) If the problem persists even after cleaning, replace the dust collection filter. (▶Page 43)
Operating sound is loud	<ul style="list-style-type: none"> Is the dust collection filter properly attached? → If it is not properly attached, operating sounds may become louder. (▶Page 43)

Troubleshooting

Indicator lamps

Phenomenon	Check points
The odour sensor lamp blinks	<p> • Is the deodorising filter attached? → Attach the deodorising filter properly. (▶Page 14, 15)</p>
The humidifier lamp blinks	<p> • The humidifier lamp slowly blinks during humidifying filter drying operation. → If you do not want to perform humidifying filter drying operation, change the setting. (▶Page 33, 34)</p>
The communication lamp remains red	<p> • Is the router power supply turned off? → Turn on the router power supply.</p> <p>• Are you using a different router from before? → Perform connection settings again with the new router. (▶Page 18-20)</p> <p>• Is the router connected to a network? → Check the network connection.</p>
	<p> • The signal transmission condition may be poor. → Move the router closer to the product.</p>
The communication lamp blinks red	<p> • An electrical component may be malfunctioning. → Press  to turn off the communication lamp, then turn it on again. If the communication lamp blinks again after about 3 minutes, an electrical component is malfunctioning. Contact the place of purchase.</p>
The water supply lamp turns on and off repeatedly	<p> Even after the water supply lamp has turned on, depending on the FAN setting, water in the humidifying tray may ripple and move the float causing the water supply lamp to turn on and off repeatedly. (This is because the on/off status of the water supply lamp is dependent on float position.) → Stop operation, unplug the power supply plug, and then fill the water tank with water. (▶Page 16, 17)</p>
The PM2.5 sensor lamp, Humidity sensor monitor lamp, odour sensor lamp, Daikin eye, and AIR MONITOR indicator do not light up	<p> • Is the indicator lamp brightness set to “OFF”? → To turn on the lamp, change the indicator lamp brightness to “BRIGHT” or “DIM”. (▶Page 11)</p>
The PM2.5 sensor lamp remains orange or red	<p> • Is there a buildup of dust on the air intake for PM2.5 sensor or the surrounding area? → Vacuum off any dust from the air intake using a vacuum cleaner. (▶Page 35)</p> <p>• Is the cover of the air intake for the PM2.5 sensor removed? → Securely attach the cover. (▶Page 35)</p> <p>• Is the PM2.5 sensor lens dirty? → Wipe off the dirt on the lens with a dry cotton bud. (▶Page 35)</p> <p>• Is the pre-filter dirty? → Clean it. (▶Page 35)</p>
<p>The PM2.5 sensor lamp is always blue and does not change</p> <p>The PM2.5 concentration value displayed with the AIR MONITOR indicator is always “--”, and Daikin eye remains blue and does not change</p>	<p> • Is the cover of the air intake for the PM2.5 sensor removed? → Securely attach the cover. (▶Page 35)</p> <p>• If the displayed value remains “--” even after you set the AIR MONITOR indicator to display the concentration of PM2.5, the PM2.5 sensor may be defective. → If the problem persists even when the cover is attached correctly, contact the place of purchase.</p>
The PM2.5 measurement device in the room and the PM2.5 monitor on the unit display different readings.	<p> • This is because the concentration of PM2.5 become uneven due to the air flow even in the same room. Please use the PM2.5 monitor display as a rough estimate.</p>
	<p> • Is there dust in the pre-filter or dust collection filter? → Dust buildup on the pre-filter or dust collection filter may cause the PM2.5 monitor display to be out of alignment. Clean the pre-filter and dust collection filter. (▶Page 35, 36)</p>







■ In the event of malfunction during operation

If the indicator lamps on the unit indicator panel light up abnormally during operation due to a lightning strike etc., and operation becomes impossible, remove the power supply plug, wait at least 5 seconds then reinsert the power supply plug and start operation again.

Phenomenon	Check points
<p>The water supply lamp remains on even though water was added</p>	<p>?</p> <ul style="list-style-type: none"> • Is the humidifying tray securely attached? → Push it all the way in. (▶Page 39) • Is the float inside the humidifying tray stuck? Is the float inside the humidifying tray properly attached? → Attach the float properly and check that it moves smoothly. (▶Page 39) <p>✓</p> <ul style="list-style-type: none"> • If the water supply lamp is lit even though there is water in the humidifying tray, there may be a problem with the water tank. (Water leakage may result) → Contact the place of purchase.
<p>There is an odour but the odour sensor lamp remains blue</p>	<p>?</p> <ul style="list-style-type: none"> • Was a strong odour already present at the time you plugged in the power supply plug? → The basic sensitivity of the odour sensor will be determined by odour levels in the first 1 minute after the power supply plug is inserted. (▶Page 10) <p>If you remove the power supply plug when the air is clean (odour free), wait at least 5 seconds, then reinsert the power supply plug and start operation, the reference odour level that determines the sensitivity of the odour sensor will be adjusted.</p> <ul style="list-style-type: none"> • Is the airflow rate limit when the water supply lamp is lit set to “Fan stop”? → If the airflow rate limit when the water supply lamp is lit is set to “Fan stop”, the fan will stop when the water supply lamp is lit. While the fan is stopped, the odour sensor may not respond well. (▶Page 33, 34)
<p>The streamer lamp blinks</p>	<p>✓</p> <ul style="list-style-type: none"> • It is time to replace the streamer units. → Contact the place of purchase.
<p>Sometimes the streamer lamp does not light up</p>	<p>✓</p> <ul style="list-style-type: none"> • The streamer may cease operating depending on the degree of air impurity and airflow rate. (▶Page 28) <p>?</p> <ul style="list-style-type: none"> • Is streamer output set to “Low”? → When set to “Low”, the streamer operates for a shorter time compared to when it is set to “Normal”. (▶Page 27, 28) • Is the unit operating in ECONO MODE? → The streamer lamp does not light up when the unit is in Monitoring mode during ECONO MODE. (▶Page 25) • Is the humidifier lamp blinking? → Humidifying filter drying operation is being carried out. The streamer lamp doesn't light up during humidifying filter drying operation.

Troubleshooting

■ Air purifying function

Phenomenon	Check points
There is no air purifying effect	<ul style="list-style-type: none">  • Is it installed in a location where the airflow cannot reach, or are there obstacles around it? → Choose a location where there are no obstacles and the airflow coming out of the unit can reach all areas of the room. • Is the louvre closed? → Open the louvre. ▶Page 21 • Is the pre-filter or dust collection filter dirty? → Clean these parts. ▶Page 35, 36
There is an odour coming from the air outlet	<ul style="list-style-type: none">  • This air purifier is a device which gathers all the dust and odour throughout an entire room. If there are strong odours or constantly-emitted odours in the room, the odours will not be able to be eliminated, and may adhere to the unit or the filter, causing the re-emission of the odours for a few weeks to a few months.
	<ul style="list-style-type: none">  • Is there a strong odour in the room, or anything in the room that is giving off an odour continuously? (Paint, new furniture, wallpaper, aerosols, cosmetics, medicine, aromatic substances, aroma oils, cigarettes, roasted meat, etc.) → Use a ventilator at the same time or run the unit in a well-ventilated room until the odour disappears. • Is the room temporarily filled with strong odours due to something such as many people smoking or cooking? → The odour will gradually fade as the unit operates. • Did you move the unit to another room? → Odour from the room the unit was previously in may still be present. Keep operating until the odour disappears. • Is there an odour coming from the deodorising filter, dust collection filter, humidifying filter, or humidifying tray? → Clean these parts. ▶Page 36, 39-41
	<ul style="list-style-type: none">  • Discard the water in the humidifying tray every day. • When performing Air Purifying Operation, discard the water in the water tank and humidifying tray. • Do not apply deodorising spray or other types of spray to the unit, or use near the unit. • In some cases the air outlet may emit a slight odour as trace amounts of ozone are generated when streamer discharge or active plasma ion discharge is happening. However, the amount is negligible and is not harmful to your health. • If an odour comes out of the air outlet when operation is started, set the airflow rate to “Turbo” and continue operating until the odour disappears. ▶Page 22 • If you are concerned about the odour from the air outlet, you can suppress the generation of odour by setting the airflow rate limit when the water supply lamp is lit to “Fan stop”. ▶Page 33, 34
Air does not come out	<ul style="list-style-type: none">  • Is the air outlet or air inlet blocked? If the air outlet or air inlet is not blocked, an electrical component is malfunctioning. → Contact the place of purchase. • Is the airflow rate limit when the water supply lamp is lit set to “Fan stop”? → If the airflow rate limit when the water supply lamp is lit is set to “Fan stop”, the fan will stop when the water supply lamp is lit. There is no airflow while the fan is stopped. ▶Page 33, 34
The airflow rate cannot be adjusted	<ul style="list-style-type: none">  • Is the odour sensor lamp blinking? → Attach the deodorising filter and filter fixing unit properly. ▶Page 14, 15





■ In the event of malfunction during operation

If the indicator lamps on the unit indicator panel light up abnormally during operation due to a lightning strike etc., and operation becomes impossible, remove the power supply plug, wait at least 5 seconds then reinsert the power supply plug and start operation again.

■ Humidifying function

Phenomenon	Check points
<p>Humidification does not occur even though the water tank contains water (The humidifying filter unit does not rotate)</p> <p>The water in the water tank is not being used up</p>	<ul style="list-style-type: none"> <input checked="" type="checkbox"/> • Since this unit achieves humidification through vaporisation, the water is used up slowly when ambient humidity is high or the temperature is low. • The Humidifying Operation stops when room humidity reaches the target humidity set for the Humidifying Operation. (▶Page 23) <hr/> <ul style="list-style-type: none"> <input type="checkbox"/> • Is the humidifier lamp lit? → If the lamp is not lit, press HUM . • Are the humidifying filters and humidifying filter unit attached properly? (▶Page 39, 42) → Attach the humidifying filters and humidifying filter unit properly. • Is the float in the humidifying tray attached properly? (▶Page 39) → Attach the float in the humidifying tray properly. • Are there any water scales or dirt on the humidifying filters? → Water scales or dirt buildup on the humidifying filters can cause reduced performance. Dirt buildup on the humidifying filters varies according to water quality and may result in reduced performance. Clean the humidifying filter unit. (▶Page 39-41) • Is the water supply lamp lit? → If it is lit, the humidifying tray is not properly attached. Re-attach the humidifying tray. (▶Page 39) • Is the odour sensor lamp blinking? → If it is blinking, the deodorising filter or the filter fixing unit is not attached properly. If the deodorising filter or filter fixing unit is not attached properly, the airflow rate will decrease and Humidifying Operation will stop. Attach the deodorising filter and filter fixing unit properly. (▶Page 14, 15)
<p>The humidifying filter does not rotate</p>	<ul style="list-style-type: none"> <input type="checkbox"/> • Is the airflow rate limit when the water supply lamp is lit set to “Fan stop”? → If the airflow rate limit when the water supply lamp is lit is set to “Fan stop”, the fan and humidifying filter will stop when the water supply lamp is lit. (▶Page 33, 34)
<p>The AIR MONITOR indicator always indicates a high humidity level when the humidity display is selected</p>	<ul style="list-style-type: none"> <input type="checkbox"/> • Is the unit positioned next to a window or in a location exposed to cold wind? → There is a possibility that only the air surrounding the unit is of high humidity. Try moving the unit to a different location. <input checked="" type="checkbox"/> • Room with poor sunlight or poor ventilation or rooms close to wet areas, such as the bathroom, become humid easily, so these rooms tend to have a higher humidity. • Immediately after starting operation, the humidity may be displayed higher than it actually is, depending on the condition of the air inside the unit. Continue operation for about 1 hour and check again.
<p>The values of humidity and temperature indicated on the unit differ from other hygrometers and thermometers</p>	<ul style="list-style-type: none"> <input checked="" type="checkbox"/> The display on the unit may differ from that of the other hygrometers or thermometers. • This is because the humidity and temperature become uneven even in the same room due to the flow of air. Please use the Air monitor indicator as a rough estimate. <hr/> <ul style="list-style-type: none"> <input type="checkbox"/> • Is the airflow rate limit when the water supply lamp is lit set to “Fan stop”? → If the airflow rate limit when the water supply lamp is lit is set to “Fan stop”, the fan will stop when the water supply lamp is lit. While the fan is stopped, the humidity sensor and temperature sensor may not respond well. (▶Page 33, 34)

Troubleshooting

Phenomenon	Check points
Ambient humidity does not rise	<ul style="list-style-type: none"> When the indoor or outdoor humidity is low, the walls and floor of the room are dry, or the room has poor insulation against drafts, the target humidity may not be readily achieved.
	<ul style="list-style-type: none"> Is the humidity setting to “ (Low)” or “ (Standard)”? Is the FAN setting set to “ (Quiet)” or “ (Low)”? → Set the humidity setting to “ (High)” and increase the FAN setting. ▶Page 22, 23 Is the odour sensor lamp blinking? → Attach the deodorising filter and filter fixing unit properly. ▶Page 14, 15
Room humidity is high but Humidifying Operation does not stop	<ul style="list-style-type: none"> When indoor or outdoor humidity is high, the walls and floor of the room are moist, or the room has good insulation against drafts, the target humidity may be exceeded.
	<ul style="list-style-type: none"> Is the unit exposed to direct sunlight or warm air from a heating appliance? → Move the unit to a location without such direct exposure.
	<ul style="list-style-type: none"> Perform during Humidifying Operation as well as Air Purifying Operation. If the set humidity is reached during Humidifying Operation, Humidifying Operation will stop, but Air Purifying Operation will continue.
The water supply lamp is lit but Humidifying Operation does not stop (the humidifying filter unit continues to rotate)	<ul style="list-style-type: none"> Even if the water supply lamp lights up, the humidifying filter unit will continue to rotate for about 90 minutes in order to reduce the amount of water remaining in the humidifying tray. If you want to continue Humidifying Operation, please add water to the water tank. ▶Page 9, 16, 17, 37, 38
Water in the water tank is decreasing even though Humidifying Operation is not running	<ul style="list-style-type: none"> Even when performing only Air Purifying Operation, if there is water in the tank, the air will be slightly humidified due to natural evaporation because of air flow, and the water in the water tank will be used up. When performing only Air Purifying Operation, discard the water in the water tank and humidifying tray.
Water splashes out from the air outlet	<ul style="list-style-type: none"> Are the pre-filter, dust collection filter, humidifying filters, and water tank attached properly? ▶Page 16, 17, 35, 39, 42, 43 → Attach them properly. When you removed the humidifying filters from the frame and replaced them <ul style="list-style-type: none"> Did you shape the new filters properly before attaching them? Did you attach all 2 of them? Did you attach them so that the engraved pattern on the frame matches the pattern on the humidifying filter? → Attach them properly. ▶Page 42
The airflow rate does not reach the set level during Humidifying Operation	<ul style="list-style-type: none"> Even if you have selected an airflow rate that suits your preferences, if the water supply lamp lights up, the airflow rate will change to “Quiet”. If you do not want the airflow rate to change to “Quiet”, change the setting. ▶Page 33, 34 (Depending on the degree of odour and dust, the airflow rate may not change to “Quiet”.) In order to make it easier for the humidifying filter to absorb water, the “Turbo” airflow rate will be suppressed for about 10 minutes from the start of the humidifying operation. After that, the operating sound changes because the airflow rate also changes to the set airflow rate. ▶Page 23











■ Wireless LAN connection

Phenomenon	Check points
The unit (air purifier) can't be found with the app	<ul style="list-style-type: none"> Perform connection settings again. ▶Page 19, 20 Move the router closer to the air purifier.
Cannot operate the unit with smartphone even though the communication lamp is lit green	<ul style="list-style-type: none"> Check the internet connection of your router.

■ **In the event of malfunction during operation**

If the indicator lamps on the unit indicator panel light up abnormally during operation due to a lightning strike etc., and operation becomes impossible, remove the power supply plug, wait at least 5 seconds then reinsert the power supply plug and start operation again.

■ **Other**

Phenomenon	Check points
<p>The unit is operating even though I didn't press any buttons The unit stopped operating even though I didn't press any buttons</p>	<p> • Is someone else operating the unit with a smartphone? • Did you set the schedule timer using "ONECTA"? → If  is pressed on the unit, the communication lamp will turn off, and operation via smartphone and the schedule timer will be disabled.</p>
<p>The fan stops during operation</p>	<p> • During ECONO MODE or AUTO operation, when Monitoring mode is entered, the fan turns on and off repeatedly. (▶Page 25)</p> <p> • Are you operating with the pre-filter, dust collection filter, humidifying filter unit, humidifying tray, and water tank removed? If you forget to attach a component, the fan may stop to protect the electrical components. → If you forgot to attach a component, remove the power supply plug, attach the component correctly, and then restart operation.</p> <p>• Is the airflow rate limit when the water supply lamp is lit set to "Fan stop"? → If the airflow rate limit when the water supply lamp is lit is set to "Fan stop", the fan will stop when the water supply lamp is lit. (▶Page 33, 34)</p>
<p>The sound of streamer discharge can no longer be heard</p>	<p> • The operation of the streamer may stop depending on the degree of air impurity and the airflow rate. (▶Page 28)</p> <p> • Is streamer output set to "Low"? (▶Page 27, 28)</p>
<p>After performing Humidifying Operation in Humidifying and Air Purifying Operation or in a MODE, operation is stopped, but humidifying filter drying operation is not performed</p>	<p> • Even if Humidifying Operation is "ON", if the humidity in the room exceeds the set humidity and Humidifying Operation is not performed for 1 hour or more, humidifying filter drying operation will not be performed.</p> <p>• Is humidifying filter drying operation set to "OFF"? (▶Page 33, 34)</p>
<p>There is water spilled on the floor</p>	<p> • Have you tilted the unit? → If you tilt the unit, water may spill out. Before moving the unit, turn off the power and discard any water in the water tank and humidifying tray.</p> <p>• Is there a large buildup of water scales on the humidifying filters? → Water leakage may result from water scale buildup. Clean it. (▶Page 39-41)</p> <p>• Is the float stuck? → If the float is stuck, water leakage may result. Clean it. (▶Page 39)</p> <p>• Is dust caught in the valve of the water tank? → If dust is caught in the valve, the valve will not close, and water leakage may result. Clean it. (▶Page 37, 38)</p> <p>• Are water scales adhered to the area around the valve of the water tank? → If water scales are adhered to the area around the valve, the valve will not close, and water leakage may result. Clean it. (▶Page 37, 38)</p>
<p>The TV screen shows interference The radio emits noise</p>	<p> • Is the TV or radio positioned within 2m of the unit, or is an indoor antenna positioned near the unit? • Are the power supply cord or antenna cable of the TV or radio routed near the unit? → Keep the unit as far as possible from the TV, radio or antenna.</p>
<p>Just inserting the power supply plug causes operation to start</p>	<p> • Did you disconnect the power supply plug during a power failure or when a sudden voltage fluctuation occurred? Or did you stop the unit by disconnecting the power supply plug during the last operation? → The auto-restart function automatically resumes operation.</p>
<p>The metal filter has detached from the water tank lid</p>	<p> • Did you push the metal filter hard from the reverse side? → The metal filter may become detached when cleaning, etc. If the unit is used without the filter attached, contamination with dust etc., could result in water leakage. Therefore, please attach the filter in accordance with "If metal filter detaches from water tank lid". (▶Page 38)</p>

Specifications

Model name	MCK70ZVM-W / MCK70ZVM-H							
Power supply	Single phase 50Hz 220-240V / 60Hz 220-230V							
Operation mode	Air Purifying				Humidifying and Air Purifying (at indoor temp.: 20°C, indoor humidity: 30%)			
	Turbo	Standard	Low	Quiet	Turbo	Standard	Low	Quiet
Power consumption (W)	82	20	11	10	84	23	12	10
Operating sound (dB)	54	37	27	18	54	37	27	18
Airflow rate (m ³ /h)	420	210	132	84	420	210	132	84
Humidifying rate (mL/h)	-				700			
Coverage area (m ²)	48				-			
	96				-			
CADR (m ³ /h)	375				-			
External dimensions (mm)	760(H)× 315(W)× 315(D)							
Weight (kg)	12.5 (when the water tank is empty)							
Water tank volume (L)	About 3.4 *6							
Power supply cord length (m)	2							

- These specification values are applicable to both 50Hz 220–240V and 60Hz 220–230V.
 - Even when the power is off, about 1W (*7) of power is consumed to run the microcomputer.
 - This appliance is designed to be used in residential or commercial areas.
 - A-weighted emission sound pressure level is below 70dB(A).
- *1. When there is water in the water tank, the water may decrease and ambient humidity may rise slightly.
- *2. Humidifying rate was calculated in accordance with JEM1426. (when FAN setting is “Turbo”)
- *3. Coverage area was calculated in accordance with JEM1467. (when FAN setting is “Turbo”)
- *4. Coverage area was calculated in accordance with NRCC-54013 standard using cigarette smoke CADR.
- *5. CADR was tested in accordance with JEM1467. (when FAN setting is “Turbo”)
- *6. When the water tank is filled while installed in the unit. If water tank is removed from the unit before filling, the water tank volume is 2.5 liters in order to make carrying easier.
- *7. If the wireless LAN connection adapter function is “OFF”.

Humidifying rate
(at indoor temp.: 20°C, indoor humidity: 30%)

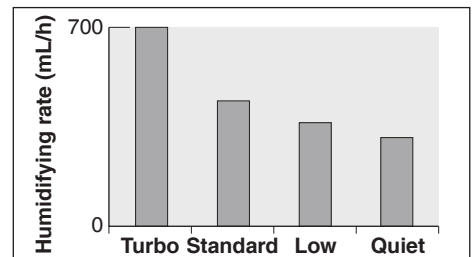

Separately Sold Parts

Contact the place of purchase.

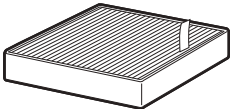
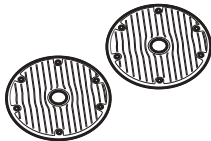
Replacement part	Replacement part
<p>Dust collection filter (1 pc.) Model: BAFT501A</p>	<p>Humidifying filter (without frame) (2 pcs.) Model: KNME108A4E</p>
	
<ul style="list-style-type: none"> • Replace about every 10 years. • Catches dust and pollen. 	<ul style="list-style-type: none"> • Replace about every 10 years. • Humidifies air by vaporising water during Humidifying Operation.

- Failure to maintain parts properly may result in:
 - Reduced air purifying capacity
 - Reduced deodorising capacity
 - Emission of odours
- Observe local waste separation rules when disposing of the dust collection filter (made of polyester and polypropylene) and the humidifying filter (made of polyester).

■ Disposal requirements

- Units are marked with the following symbol:



This means that electrical and electronic products may not be mixed with unsorted household waste. Do NOT try to dismantle the system yourself: the dismantling of the system, treatment of the refrigerant, of oil and of other parts must be done by an authorized installer and must comply with applicable legislation.

Units must be treated at a specialized treatment facility for reuse, recycling and recovery. By ensuring this product is disposed of correctly, you will help to prevent potential negative consequences for the environment and human health. For more information, contact your installer or local authority.