

5. Battery Maintenance & Repair

- This series of UPS only needs very little maintenance. The batteries of the standard machine are seal type and no need to maintain frequently. But also keep charging to get the expected battery life. UPS keep charging when it is connecting to AC, no matter on/off. And it also has function of over charging and overload protection.
- If you don't use UPS for a long time, you should charge the UPS every 4-6 months. In the areas of high temperature, battery should be charging and discharging every two months, the charging time should not be less than 12 hours.
- In normal circumstances, service life of the battery is 3-5 years. If the battery is found to be in poor condition, it must be replaced in advance. When replacing the battery, it must be done by a professional.
- When replacing the battery, follow the principle of quantity Model consistent and model Model consistent.
- The battery should not be replaced individually and when it is replaced as a whole should be according to the battery supplier's instructions.
- In normal circumstances (under the condition of UPS with little back up power), the battery should be charged and discharged every 4-6 months. Keep discharging before UPS shut down then keep charging. The standard machine charging time should not be less than 12 hours.

Product are subject to change without notice.

USER MANUAL

**1K(L)/2K(L)/3K(L)
6K(L)/10K(L)**

Uninterruptible Power Supply

Safety precautions

Operation safety

1. Before using this product, please read "safety precautions" carefully to ensure correct and safe use, and please keep the manual properly.
2. During operation, please pay attention to all warning signs and operate as required.
3. Avoid using the device in direct sunlight, rain or humid environment.
4. This equipment cannot be installed near the heat source area or similar equipment such as electric heater and hot stove.
5. A safe distance and ventilation shall be reserved around the UPS. Please refer to the manual for installation.
6. Please use dry cleaning tools for wiping or cleaning the UPS.
7. In case of fire, please use the dry powder extinguisher correctly. There is a risk of electric shock if a liquid fire extinguisher is used.

Electrical safety



1. The battery life is shortened with the increase of ambient temperature. Regular battery replacement can ensure the UPS to work normally and ensure sufficient backup time.
2. Battery maintenance can only be carried out by personnel with battery expertise.
3. There is a risk of electric shock and short circuit current in the battery. In order to avoid personal injury caused by electric shock, please observe the following warnings when replacing the battery:
 - A. Do not wear watches, rings or similar metal objects.
 - B. Use insulated tools.
 - C. Do not place metal tools or similar metal parts on the battery.
 - D. Before removing the battery connection terminal, the load connected to the battery must be disconnected.
4. Please do not expose the battery to the fire to avoid explosion and personal safety.
5. Non-professionals should not open or damage the battery, because the electrolyte in the battery contains dangerous substances such as strong acid, which will cause harm to the skin and eyes. If you accidentally touch the electrolyte, immediately wash it with plenty of water and go to the hospital for examination.
6. Please do not short-circuit the positive and negative poles of the battery, which may cause electric shock or fire.

Use and maintenance

1. The use environment and preservation method have influence on the service life and reliability of this product. Please do not use it in the following working environment:
 - A. High, low temperature and humid places exceeding the technical specifications (temperature 0 °C - 40 °C, relative humidity 20% - 90%).
 - B. Places with vibration and vulnerability.
 - C. Places with metal dust, corrosive substance, salt and combustible gas.
2. If it is not used for a long time, the UPS (without battery) must be stored in a dry environment, and the storage temperature range: - 15 °C ~ + 60 °C. Before starting UPS, the ambient temperature must be warmed to above 0 °C and maintained for more than 2 hours.

Fault code	Indication	Possible reasons	Treatment measure
81	Unknown battery QTY setting	Number of Battery wrong	1. Check whether the battery number meets the requirements 2. Check if the configuration of the battery jumper cap is the same as the software setting
82	Battery QTY setting matching error	Number of Battery setting wrong and can not be matched with software setting	

4.3 Common faults and trouble shooting

Number	Problem or errors Description	Reason	Solution
1	Connect to city electricity, and no display on LCD display panel	No Input power	Check if the input wiring harness of UPS is in well connection
		Input voltage under voltage or overload	Use voltage meter to check the input voltage if in normal or meets the requirements
2	City electricity in normal, no AC current Input indicator, UPS is still working in battery mode	UPS power switch is still off	Press UPS city electricity power switch on
		The wiring harness is loosen or in poor connection	Check the input wiring harness if in normal
3	UPS no display error, but no output voltage	The wiring harness is loosen or in poor connection	Make sure the wiring harness in well connection
4	Press  button, UPS did not start	Press button to shortly	Press  over 5 seconds, hear "Di" sound
		overloads	Remove all loads and restart machine
5	With City electricity, but no City electricity indicator	Mains voltage or frequency over UPS input range	Use a multimeter to check the input voltage, whether the input frequency meets the requirement
6	The battery discharge time is lower than the standard time	The power of battery has been used	Change new battery
		The battery did not charge in full	Charge the battery more than 8 hours under normal city electricity, then retest it
7	Abnormal sound or smell come out from the inside of UPS	Inner of UPS may be damaged	Please immediately turn off the UPS, cut off the power input, and contact the customer service center for technical support
8	Battery mode display yellow light, long buzzer sounds, battery capacity is insufficient, ready to shut down	The power of battery is low, UPS is ready to shut down, and the loads will be cut off	1. Save the data on the loads immediately and complete shutdown the important loads to avoid data loss or damage. 2. Immediately connect the UPS input terminal to the standby AC power supply

Fault code	Indication	Possible reasons	Treatment measure
3	Bus under voltage	1. city electricity is too low 2. software processing errors 3. BUS capacitor failure	Please check the city electricity, if no any abnormal, please contact supplier
7	Over temperature	1. Fan failure 2. The air duct on the rear panel of the UPS is blocked 3. Overload 4. NTC hardware abnormality or abnormal wiring 5. Power device IGBT damaged	1. Please check the rectifier on the fan; 2. Clean the obstacles on the air duct of the rear panel of the UPS; 3. check the loads; 4. if all of above can not be solved, please contact supplier;
8	Battery relay short circuit	Relay RL1/RL3 hardware damaged	please contact supplier
9	Bus relay soft start fail	1. city electricity is abnormal 2. Busbar starts and loop in abnormal	Please check the city electricity, if no any abnormal, please contact supplier;
17	Inv soft start fail	1. Some hardware of Inverter is damaged; 2. Control panel is failure	please contact supplier
18	Inv output over voltage	1. Some hardware of Inverter is damaged; 2. Control panel is failure	please contact supplier
19	Inv output under voltage	1. Some hardware of Inverter is damaged; 2. Control panel is failure	please contact supplier
20	Inv short circuit	1. Some hardware of Inverter is damaged; 2. Output short circuit	1. Check if short circuit caused on the output of UPS 2. Check if the loads is short circuit 3. if no any abnormal, please contact supplier
26	Negative power protection (output with AC input fail)	1. Bypass reverse to the inverter 2. Overload abnormal	Check the loads and if no any abnormal, please contact supplier;
33	Inv relay or SCR open circuit	Relay RL8 is damaged	please contact supplier
34	Inv relay or SCR short circuit		
35	Bypass relay or SCR open circuit	Relay RL4/RL6 is damaged	please contact supplier
36	Bypass relay or SCR short circuit		
37	I/O connection reversed	Reverse wiring on input and output	Please check the wiring harness of input and output
39	Charger short circuit	1. output of Charger short circuit 2. Charger hardware abnormal	please contact supplier
66	Over load fault	1. overload too much 2. The voltage reduction causes the system rated power to decrease	1. Check if the load is within the specified range 2. Check if the pressure has been reduced
67	Charging over voltage or battery connection reversed	1. Hardware error 2. Number of Battery wrong 3. Wiring wrong	1. Check whether the battery wiring or battery number meets the requirements 2. if no any abnormal, please contact supplier
68	Unknown machine model	Software version error	1. Restart machine; 2. if no any abnormal, please contact supplier;
72	Charger over current	1. Hardware error 2. Battery abnormal	1. Check whether the battery wiring or battery number meets the requirements 2. if no any abnormal, please contact supplier;
73	No bootstrap	Software version error	1. Restart machine; 2. if no any abnormal, please contact supplier;

Content

1. Instruction	1
1.1 Symbol.....	1
1.2 Rear view.....	2
1.3 Specification.....	4
2. Installation	7
2.1 Unpacking inspection.....	7
2.2 Wiring schedule.....	7
2.3 UPS connection.....	7
2.4 External battery connection of long back up type UPS.....	8
2.5 Connection to computer surface.....	9
3. Control Panel	10
3.1 Panel display.....	10
3.2 LED indicator.....	11
3.3 Function of button.....	11
3.4 UPS working status table of LED indicator and beeping.....	12
3.5 UPS working status table of LCD display.....	12
3.6 Parameter query.....	13
3.7 Function setting.....	14
4. Warning code/fault code and solution	18
4.1 Warning code and solution.....	18
4.2 Fault code and solution.....	18
4.3 Common faults and trouble shooting.....	20
5. Battery maintenance	21

1.Introduction

This series of UPS is an on-line sine wave uninterruptible power supply system with bypass maintenance switch, which can provide reliable and high-quality AC power for your precision equipment. It can be used in a wide range, from computer equipment, communication system to industrial automatic control equipment. Because of its on-line design, it is different from the backup ups. It continuously adjusts and filters the input voltage. When the power supply is interrupted, it will provide the backup power from the backup battery without time interruption. In case of overload or inverter failure, ups will switch to bypass state and be powered by mains. If the overload condition is eliminated, the ups will automatically switch back to the inverter power supply state.

This manual is applicable to the following products, including:

- 1K : standard UPS with built-in batteries.
- 1KL: long back up time UPS which connect to external battery.
- 2K : standard UPS with built-in batteries.
- 2KL: long back up time UPS which connect to external battery.
- 3K : standard UPS with built-in batteries.
- 3KL: long back up time UPS which connect to external battery.
- 6K : standard UPS with built-in batteries.
- 6KL: long back up time UPS which connect to external battery.
- 10K: standard UPS with built-in battery.
- 10KL: long back up time UPS which connect to external battery.
- 6K/10K rack type series (external battery is required).

1.1Symbol

Symbols and meanings	
Symbols	Meanings
	Attention
	Danger
	Ac(alternating current)
	Dc(direct current)
	Protective earth conductor
	Protective connecting conductor
	Loop
	Do not place with sundries
	Overload
	Battery
	ON/OFF Switch

4.Warning code/fault code and solution

4.1 Warning code and solution

When the “⚠” symbol on the UPS LCD flashes, the UPS is in alarm state. Press the page turn key to the error state page (refer to 3.5), observe the alarm code and make appropriate processing according to the table below.

Alarm Code	Indication	Possible reasons	Treatment measure
1	No battery connection	1.Do not connect with battery 2.Battery damage	1.Check the connection of battery. 2.Change the battery
2	Battery low voltage	The battery voltage is less than the low voltage warning point. The battery discharge is below the alarm point.	After the battery has been set for a period of time, it can be turned on again. The built-in charger can be turned on to charge the battery
4	Input Neutral and Live cable is reversed.	1.Input Neutral and Live cable is reversed. 2.Input ground cable is not connected. 3. Output ground cable is not connected.	1.Reverse the Neutral and Live cable. 2. Input+B3:C14output ground cable ensures good connection.
8	Battery over voltage	UPS detects high battery voltage	Check that the battery quantity setting is consistent with the actual battery quantity.
9	Charger failure	Abnormal charger hardware	Contact with supplier
10	Over temperature alarm	1.Fan fault 2.Air duct of UPS rear panel is blocked. 3.Overload 4.NTChardware abnormal or connection abnormal 5.Power device IGBT is damaged	1.Check the rectifier fan 2.Remove UPS back plate obstruction 3.Check the load 4.If the above treatment cannot be solved, contact the supplier
12	Fan fault	1.Fan wiring is loose 2.Fan hardware abnormal	Check the fan and connection
13	AC fuse open	Fuse blown	Contact with supplier
14	EEPROM fault	EEPROM Chip damage	Contact with supplier
21	Over-load	The load exceed rated power	Check the load
22	3 times consecutive overload locks	3 times consecutive overload locks	Shut down and restart UPS
23	EPO action	Press EPO button	1. Release EPO button 2.Check the wiring harness on EPO button
24	Maintenance switch action	The maintenance switch is pressed	Release maintenance switch

4.2 Fault code and solution

When the "FAULT" is long bright, and “⚠” symbol on the UPS LCD flashes, the UPS is in fault state. UPS automatically switches to the error status page (refer to 3.5) to observe the fault code and make appropriate processing according to the following table.

Fault code	Indication	Possible reasons	Treatment measure
1	Bus boosting soft start fail	1.AC abnormal 2.Abnormal soft-starting circuit of bus	Check the Main, if all normal please contact with supplier
2	Bus over voltage	1.AC abnormal 2.Software processing error 3.BUS capacitance fault	Check the Main, if all normal please contact with supplier

02-7 : Input Neutral and Live cable reverse alarm function

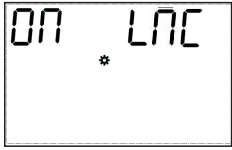
LCD Display	Setting
	<p>Input Neutral and Live cable reverse alarm mode closed by default, can choose to open to improve the safety of the system.</p>
	<p>Notice: Factory settings default closed, please open if you need.</p>

1.2Rear view

1/2/3K(L) Rear view

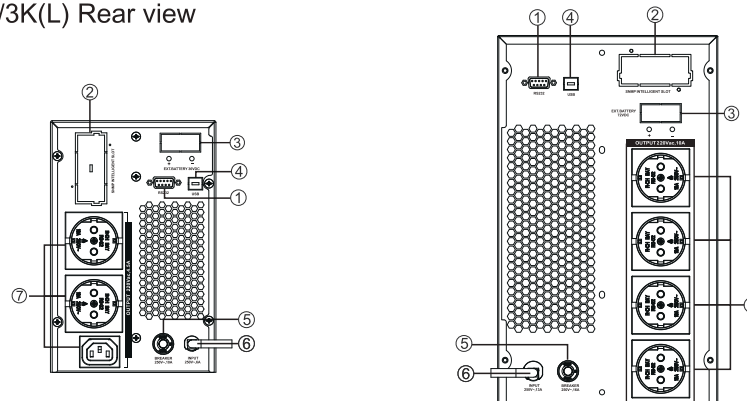

1K(L)

2K(L)

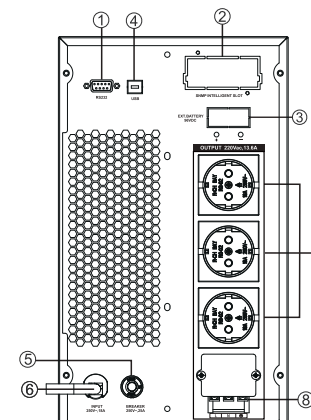

3K(L)

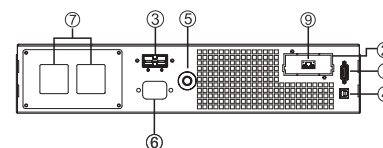

RT1K(L)/RT2K(L)/RT3K(L)

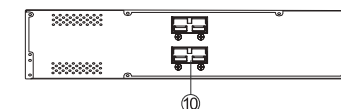

Battery Pack

- ① Computer interface
- ② Smart slot (optional)
- ③ External battery connection (only available for L model)
- ④ USB (optional)
- ⑤ Input circuit breaker
- ⑥ AC input
- ⑦ Output receptacles
- ⑧ Output terminal
- ⑨ EPO (optional)
- ⑩ Battery interface

6/10K(L) Rear view

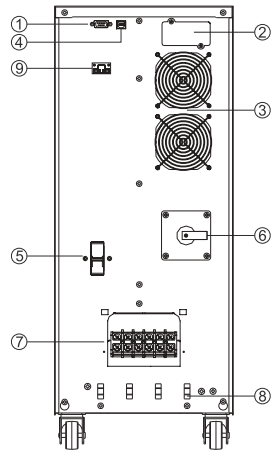

6K/10K

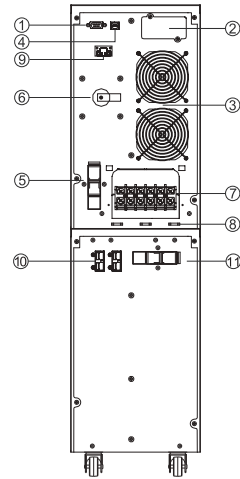

6KL/10KL

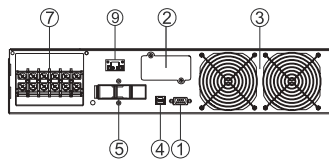

RT6K(L)/RT10K(L)

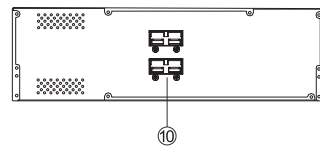

Battery Pack

- ① Computer interface
- ② Smart slot (optional)
- ③ Fan
- ④ USB (optional)
- ⑤ Input protection switch
- ⑥ Maintenance switch (optional)
- ⑦ Terminal strip
- ⑧ Corbel
- ⑨ EPO
- ⑩ Battery interface
- ⑪ Battery protection switch

02-4:Emergency shut down(EPO)

LCD Display	Setting
	<p>When EP is set to ON, the EPO option appears on the function Settings page, emergency shutdowns can be set. Emergency shutdown function default that plug EPO terminal valid (OFF), can choose to plug EPO terminal valid (ON).</p> <p>Note: After EPO action, emergency shutdown, close all outputs immediately.</p>

02-5:Battery quantity(PCS)



LCD Display	Setting
	<p>When EP is set to ON, the PCS option appears on the function Settings page, will enter the password page, enter the password (the general password is 135), you can set the number of batteries. The battery number system defaults to 16pcs, which can be set to 16/18/20pcs.</p>

02-6:Charger Current(CHG)

LCD Display	Setting
	<p>When EP is set to ON, the CHG option appears on the function Settings page, charger current can be set, 1-12A optional, default 1A; Noted: If UPS built-in batteries, the charger current default 1A, and can't be change.</p>

●02: Other functional setting

02-1: Expert Mode (EP)

LCD Display	Setting
	<p>The Expert Mode setting with ON, then go to the functional setting page again. The functional setting will show battery QTY (PCS), EPO, charging current and other items can be chosen. When the Expert Mode setting with OFF, functional setting page will show only the general options.</p> <p>Note: The Expert Mode default to OFF. When setting as ON then re-connected the AC power, the EP can be recovered as OFF.</p>
	

02-2: Battery Low voltage shutdown point/ End of Discharge voltage (EOD)

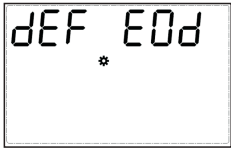
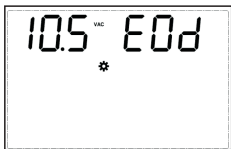
LCD Display	Setting
	<p>The options of EOD setting are dEF, 9.8V, 9.9V, 10V, 10.2V, 10.5V.</p> <p>By default, the EOD is dEF (The EOD will be changed according to loading condition. 10.5V@ Loading<25%, 10.2V@ 25%< Loading< 50%, 10V@ Loading >50%)</p>
	

02-3: Economic Operation Mode (ECO)

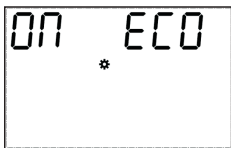
LCD Display	Setting
	<p>ECO is OFF by default, can be set as ON to improve the efficiency of system operation.</p> <p>Note: For the models with PF<1, OFF by default, and unable to set.</p>
	

1.3 Specification

MODEL	1K	1KL	2K	2KL	3K	3KL	3K	
Rate Capacity	1KVA/1KW		2KVA/2KW		3KVA/3KW		3KVA/2.4KW	
INPUT								
Input formats	L+N+PE							
Rated input voltage	208/220/230/240VAC							
Voltage range	110~300VAC, 110~176VAC, 280~300VAC(power limited)							
Frequency range	50/60±6Hz (default), ±10Hz(Settable)							
Input power factor	≥0.99							
Input Harmonic distortion	≤3% THD(linear load), ≤5% THD(non-linear load) (PF=0.8)							
OUTPUT								
Output formats	L+N+PE							
Output voltage	208/220/230/240VAC							
Output accuracy	±1%							
Output frequency	Online mode: according to AC frequency, Battery mode: 50/60Hz±0.1%							
Output Harmonic distortion	≤1% THD(linear load), ≤3% THD(non-linear load)							
Output Power Factor	1						0.8	
Switching Time	AC Mode to Battery Mode 0ms, Inverter to Bypass 4ms(Typical)							
Load Capacity	AC Mode: 30min@102%~110% Load 10min@110%~130% Load 30s@130%~150% Load 200ms@>150% Load			Battery Mode: 1min@102%~110% Load 10s@110%~130% Load 3s@130%~150% Load 200ms@>150% Load				
Machine Efficiency								
AC Mode	Full load efficiency94.5%@220VAC		Full load efficiency95.5%@220VAC		Full load efficiency95.5%@220VAC			
Battery Mode	Full load efficiency89.5%@36VDC		Full load efficiency91.5%@72VDC		Full load efficiency91.5%@96VDC			
Battery Mode	Full load efficiency89.5%@24VDC		Full load efficiency91.5%@48VDC		Full load efficiency91.5%@72VDC			
Charger								
Battery Type	Lead acid battery							
Battery Quantity	7Ah x2	36V	7Ah x4	72V	7Ah x6	96V	9Ah x4	
Charging Current	1K,2K,3K:1.0A(default), 1~2A(Settable)External battery pack; 1KL,2KL,3KL:5.0A(default), 1~12A(Settable).							
Charging Mode	Two/Three Period Charging							
Ambient Parameters								
Working ambient temperature	0~40°C							
Working ambient humidity	20%~95% (No Condensation)							
Storage temperature	-15~60°C(Battery:0~40°C)							
Altitude	<1000m, Derating at above 1000m, maximum4000m, Refer to IEC62040							
Noise level	<50db							
Gross weight (kg)	Standard case	9	5	17	9	21.4	9	—
	Small case	8.5	4.5	15	8	23.2	8	16.5
Machine size (mm)	Standard case	345*144*225		395*190*325		395*190*325		—
	Small case	285*144*225		395*144*225		460*190*335	395*144*225	395*144*225
Communication Interface								
Interface	One USB, one RS232, one EPO							
Standard and Approvals	EN/IEC 61000, EN/IEC62040, GB/T 7260, GB/T 4943, YD/T1095, TL Cetc.							

MODEL	6K	6KL	10K	10KL
Rate Capacity	0.9	6KVA/5.4KW	10KVA/9KW	
	1.0	6KVA/6KW	10KVA/10KW	
INPUT				
Input formats	L+N+PE			
Rated input voltage	208/220/230/240VAC			
Voltage range	110~300VAC, 110~176VAC, 276~300VAC(power limited)			
Frequency range	50/60±6Hz(Default), ±10HZ(Adjustable)			
Input power factor	≥0.99			
Input Harmonic distortion	≤5% THD(linear load), ≤8% THD(non-linear load)(PF=0.8)			
OUTPUT				
Output formats	L+N+PE			
Output voltage	208/220/230/240VAC			
Output accuracy	±1%			
Output frequency	Online mode:according to AC frequency ,Battery mode:50/60Hz±0.1%			
Output Harmonic distortion	≤2% THD(linear load), ≤5% THD(non-linear load)(PF=0.8)			
Output Power Factor	0.9/ 1.0			
Switching Time	0ms,ECO Mode to Battery Mode 2ms			
Load Capacity	AC Mode:	Battery Mode:		
	30min@102%~110% Load 10min@110%~130% Load 30s@130%~150% Load 500ms@>150% Load	10min@102%~110% Load 1min@110%~130% Load 10s@130%~150% Load 500ms@>150% Load		
Machine Efficiency				
AC Mode	Maximum efficiency 95.5%, Full load efficiency 95%			
Battery Mode	Maximum efficiency 95.3%, Full load efficiency 94.8%(20pcs batteries)			
Charger				
Battery Type	Lead acid battery			
Battery Quantity	All models are 16pcs/18pcs/20pcs batteries adjustable, default 16pcs. Except the model 6KVA and 10KVA(PF=0.9 internal type, 6KVA with 12pcs batteries inside, and 10KVA is 14pcs batteries inside.)			
Charging Current	Adjustable from 1~12A(PF=0.9,Adjustable 1-8A), Default 1A			
Charging Mode	Two/Three Period Charging			
Ambient Parameters				
Working ambient temperature	0~40°C			
Working ambient humidity	20%~95% (No Condensation)			
Storage temperature	-15~60°C(Battery:0~40°C)			
Altitude	<1000m,Derating at above 1000m,maximum 4000m,Refer to IEC62040			
Noise level	<50dB			

LCD Display 3: Battery voltage and capacity 	LCD Display 4: Output voltage and Output active power
LCD Display 5: Output voltage and output complex power 	LCD Display 6: Output voltage and load percentage
LCD Display 7: UPS system software version 	LCD Display 8: connected battery quantity

3.7 Function setting

•01: Output Voltage

LCD Display	Setting
	<ol style="list-style-type: none"> Press the function setting button () over 2 sec, then go to the setting page. Press the page-turning buttons till the setting page of output voltage, and the words "OPU" flashing. Press confirm button () 0.5~2 sec, then go to the setting page of Output voltage OPU. The "OPU" words light on, and the the numbers by the left side of OPU keeps flashing. Press page-turning buttons () or () 0.5~2 sec, choose different output voltage value. The optional voltage value are 208V, 220V, 230V, and 240V. The by default output voltage is 220V. Please save after setting. Turn to the voltage value which you need, and press confirm button () 0.5~2 sec, then finish the OPU setting. The number by left side of OPU will keep light on, no flashing. Press functional setting button () over 2 sec, quit the setting page and back to the home page. (Or no operation, waiting more than 30 sec., the page will come back to home page automatically) <p>Note: When the output voltage setting with 208V, the output needs to decrease related to 90%.</p>

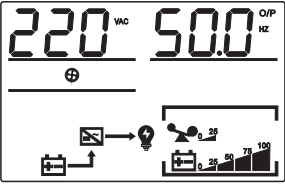
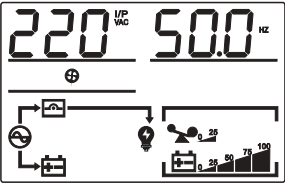
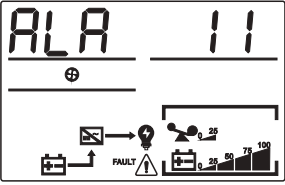
Battery Mode	
LCD display content	Instruction
	When the AC input is out of limited range or shut off, the UPS will turn to the battery mode. The batteries support output loading and will have beep every 4 seconds.
Bypass Mode	
LCD display content	Instruction
	When the AC input keeps normal, start the bypass mode and UPS closed. The UPS will turn to the bypass mode, and have beep every 2 mins.
Error Condition	
LCD display content	Instruction
	When the UPS have fault, LCD display will show the fault information.

3.6 Parameter query

Normally the LCD display can show 8 pages totally. Press the query bottom ◀ or ▶ for 0.1~2 sec can change to the different pages which shown all information, such as input, battery, output, loading, software version, temperature, and etc. If there have alarm condition, display will add 1 more page to show the alarm information. If the UPS have fault, the default display will turn to the Fault code page automatically. The home page default display will show the fault or alarm information. When UPS keeps normal working, the home page default display will show the output voltage and frequency information.

Press ▶ (right button) more than 2 sec, LCD will turn to the polling mode. Every 2 sec the shown display will turn page. Press ▶ long time, LCD will turn out of the polling mode.

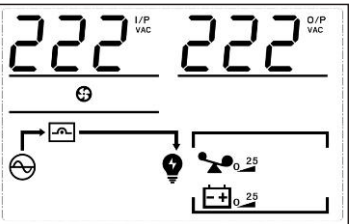
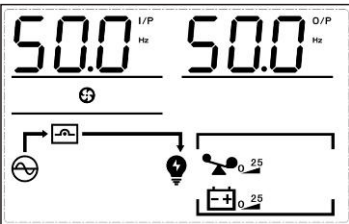
LCD Display 1: UPS input & output voltage	LCD Display 2: UPS input & output frequency
	

Connector	
Connector Type	Rs232,Extensible SNMP CARD,USB,Dry-contact card,EPO connector,Maintainance Connector.
Standard and Approvals	
EN/IEC 61000,EN/IEC 62040,GB/T 7260,GB/T 4943,YD/T1095,TLC etc.	

Load at altitude = Rated Power x Derating factor(Altitude corresponding)

Altitude(m)	1000	1500	2000	2500	3000	3500	4000	4500	5000
Derating factor	100%	95%	91%	86%	82%	78%	74%	70%	67%

⚠ Notice:If the machine is used at above 1000m,Diminishing ratings output must be used,please refer to above table for derating factor.

Because UPS model's parameters is different, so the product weight is different, please according to the physical object. If necessary, please consult with the sales.

2.Installation

Warning: To ensure safety, please pay attention to cut off the AC BREAKER before installation. The battery breaker also need to be cut off, if it is a long backup time model.

Caution:
 1.Installation and wiring must be performed by professional personnel in accordance with local regulations.
 2.UPS need to connected to the GROUND.

2.1 Symbol

Inspect the appearance of the UPS to see if there is any damage during transportation. Do not turn on the unit and notify the carrier and dealer immediately if there is any damage or lacking some parts.

Recycling : The packing boxes are recyclable, so please keep them well for using in the future.

2.2 Wiring schedule

Attention: The diameter of the cable and the cross-sectional area of the three wires depend on the real power of the UPS.

Model	AWG			
	Input	Output	Battery	Earth wire
6K	10 (6mm ²)	10 (6mm ²)	10 (6mm ²)	10 (6mm ²)
10K	8 (10mm ²)	8 (10mm ²)	8 (10mm ²)	8 (10mm ²)

2.3 UPS connection

Warning: The rated current for the switch of the AC power must be larger than the UPS maximum input current. Otherwise the switch of the AC power will be burned and destroyed.

- 1.Please choose the wire according to the table of wiring.
- 2.Remove the terminal cover on the back panel of the UPS①.
- 3.Connect the input and output wires to the corresponding input and output terminals.
- 4.Tie the wire tightly and pass through the holes②.
- 5.Tie the input, output and battery wire with the wire, adjust the wire to the appropriate position and fix the cable.

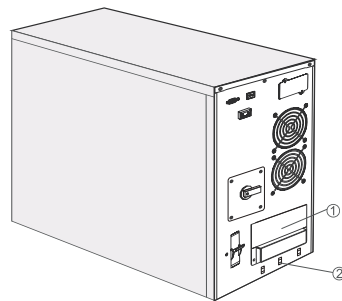

3.4 UPS working status table of LED indicator and beeping

Beeping :

Beeping	Description
Continuous beeping	Fault mode
Beep every second	Battery low voltage in DC mode
	Overload
Beep every two minutes	Bypass mode
Beep every four seconds	Other beeping

UPS working status table of LED indicator :

Working mode	Panel display				Beeping
	Inverter LED	Battery LED	Bypass LED	Fault LED	
AC mode					
Normal working	●				N/A
Warnings	●			★	Beep every second/Beep every four seconds
Battery mode					
Warnings except the battery low voltage	●	●		★	Beep every four seconds
Battery low voltage warning	●	★		★	Beep every second
Bypass mode					
Normal working			●		Beep every two minutes
Warnings			●	★	Beep every second/Beep every four seconds
ECO mode					
Normal working	●		●		N/A
Warnings	●		●	★	Beep every second/Beep every four seconds
Other mode					
Battery self-checking mode/ Boot process	★	★	★	★	Beep every four seconds
Fault mode				●	Continuous beeping

● Indicator continuous ON. ★ Indicator flashing.









3.5 UPS working status table of LCD display

AC mode	
LCD display content	Instruction
	<p>UPS can provide stable AC output when AC input in the permissible range. In the AC mode, battery will also be charged by the UPS.</p>

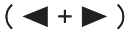
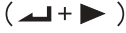
3.2 LED indicator

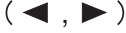
- ① Fault indicator is RED: flashing when UPS alarm, and always on when fault.
- ② Bypass indicator is YELLOW: LED is continuous on when UPS working in bypass mode or ECO mode. When UPS working in standby mode, its frequency conversion do not turn on and bypass abnormal, LED flashes.
- ③ Battery indicator is YELLOW : LED is always on when UPS work in battery mode and battery self-test mode, LED flashes and UPS alarm when battery is low.
- ④ Inverter indicator is GREEN: LED is always on when UPS work in the inverter mode (such as: AC mode, battery mode, battery self-test mode, ECO mode, frequency conversion mode).

3.3 Function of button

Button	Functional Description
Combo key for turning on the UPS ()	Electricity AC Mode: press these two start button groups at the same time and over 1 second to start UPS. Battery Mode: please press()confirm button first, after turn on the screen, please press these two start button groups at the same time and over 1 second to start UPS.
Combo key for turning off the UPS ()	Electricity AC Mode: press these two turn off button groups at the same time and over 1 second to turn off inverter output, system will change to bypass mode. Battery Mode: press these two turn off button groups at the same time and over 1 second to turn off inverter output, after 1 minute, system will shut down, and screen will turn off.
Combo key for self-checking and mute function ()	Testing: in electricity AC mode,press these two testing/mute button groups at the same time and over 2 second, to test the battery. Mute: In battery mode/Alarm/testing mode, press two testing/mute button groups at the same time and over 2 second, to erase Alarm, press two testing/mute button groups again and over 2 second, to recover Alarm.
Function setting/confirmation key ()	Function setting: press the key more than 2 seconds to enter the function setting page, determine the options and press the key more than 2 seconds again to return to the main page. Confirmation: in the function setting page, press the confirmation key 1 sec to 2 secs to confirm the setting options.
Page turning/query key ()	Page turning: Press  or  key 1 to 2 seconds to turn to left or right page Polling mode: press the  key more than 2 seconds to enter polling mode, circularly display each page content for 2 seconds, press  more than 2 seconds again to return to the main page.

 Warning: When you are connecting the wire, please make sure that the input , output wire and the input , output terminals are connected tightly.

Terminals block:

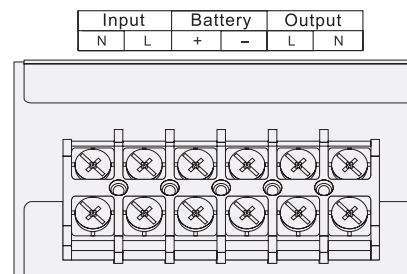

6K(L)/10K(L)

6.Reinstall the cover and lock the cover with a screwdriver①.

7.After connecting the wire and AC, then put the UPS INPUT BREAKER to "ON", the UPS will be powered.

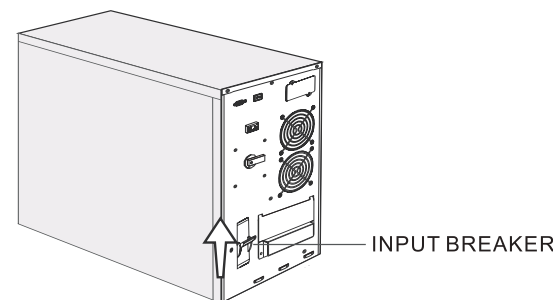

2.4 External battery connection of long back up type UPS

The nominal DC voltage of external battery pack is 192VDC. Each battery consists of 16 pieces of 12V in series. To achieve longer back time, it is possible to connect multi-battery pack.

The battery connecting procedure is very important, if you don't follow the procedure, you may encounter the hazardous of electric shock. So please strictly follow the steps below.

- 1.Set the battery BREAKER in "OFF" position and connect suitable battery in series.
- 2.Selecting a suitable battery cable to connect between the battery pack and UPS.
(Refer to table 2.2) A DC breaker must be connected between the battery pack and the UPS. The capability of breaker must be not less than the data specified in the general.

Model	6K(L)	10K(L)
Battery Voltage	192VDC	192VDC
Battery current	34A.max	56A.max

Warning: Please do not connect to the terminals of UPS first, otherwise you may encounter the hazardous of electric shock.

3.Connect the other end of the battery cable to the UPS, and then connect to the battery pack. The UPS does not connect any load first, and then turns the battery pack switch to "ON", then turn on AC, the UPS begins to charge.

Caution:  Grounding mark.

2.5 Connection to computer surface

RS232: Using RS232 to connect UPS with monitoring equipment

- 1.Using RS232 communication cable to connect to the computer's RS232 port first.
- 2.Then using the other terminal of RS232 to connect to the UPS's RS232 port.

USB: Using USB to connect UPS with monitoring equipment

1. Using USB communication cable to connect to the computer's USB port first.
2. Then using the other terminal of USB to connect to the UPS's USB port.

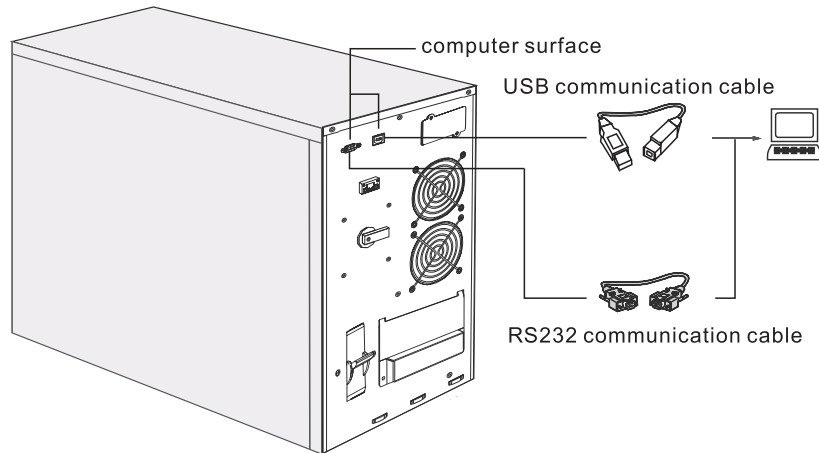



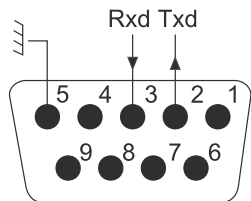





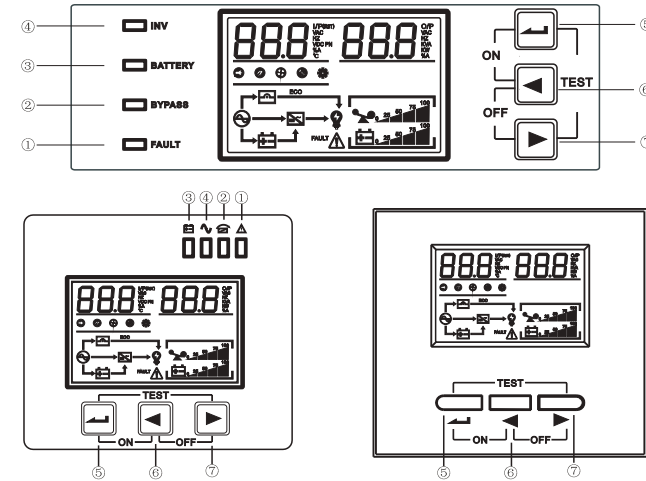

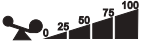
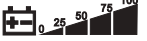

RS232 Interface on UPS :



3.Control Panel

3.1 Panel display



Display	Function
Error message	
FAULT	Failure occurred
	Warnings
BB	Fault code
Mute	
	Mute function
Input and output voltage, DC voltage, UPS internal temperature	
88.8 <small>VAC</small>	VAC: input and output voltage VDC: DC voltage °C : UPS internal temperature HZ : Frequency
Load information	
	The load volume(0~25%,26%-50%,51%-75%,76%-100%) is shown here,and the overload icon flashes when overload.
Battery information	
	The battery capacity(0~25%,26%-50%,51%-75%,76%-100%) is displayed separately, and the battery icon flashes when the battery is low or not connected.
Other information	
	AC
	BATTERY
	Bypass
	Inverter
	Output working
	Fan status: LED will always on when the fan is normal, and flashes when the fan is failure.
	Setting icon: when entering the setting menu, the icon will light up, and the icon does not show in the other cases.
	ECO function: Icon lights up when ECO function is used, otherwise the icon is not displayed.
	Maintenance icon: When the maintenance switch is turned on, the icon lights up. In other cases, the icon does not display.