



# USER GUIDE

T-REX-10KLP3G01

*Hybrid inverter*



# Contents

<b>1. SAFETY &amp; WARNING</b> .....	2
<b>2 Product Introduction</b> .....	2
2.1 Products overview .....	3
<b>3 INSTALLATION</b> .....	5
3.1 Packing List.....	5
3.2 Installation tools .....	6
3.3 Installation Environment .....	6
3.4 Mounting .....	8
<b>4. ELECTRICAL CONNECTION</b> .....	9
4.1 PV Connection .....	9
4.2 Battery Connection.....	10
4.3 On-Grid & Back-Up Connection .....	11
4.4 Smart Meter & CT Connection .....	13
4.5 Dry Contact Signal .....	15
4.6 DRMS Connection .....	15
4.7 Lithium Battery Communication .....	17
4.8 Installation of WiFi module .....	18
4.9 Wiring System .....	19
<b>5. Display and operation</b> .....	20
5.1 Operation and Display Panel.....	20
5.2 LCD Display Icons.....	21
5.3 Base information Page.....	22
<b>6. Work Mode</b> .....	24
<b>7. Warning Code Table</b> .....	27
<b>8. Troubleshooting</b> .....	27
<b>9. Appendix</b> .....	30

## About This Manual

The manual mainly describes the product information, guidelines for installation, operation and maintenance. The manual cannot include complete information about the photovoltaic (PV) system.

## How to Use This Manual

Read the manual and other related documents before performing any operation on the inverter. Documents must be stored carefully and be available at all times. Contents may be periodically updated or revised due to product development. The information in this manual is subject to change without notice. The latest manual can be acquired via our website at <https://www.felicityess.com> for latest version.









## Safety Introductions

This chapter contains important safety and operating instructions. Read and keep this manual for future reference.

- Before using the inverter, please read the instructions and warning signs of the battery and corresponding sections in the instruction manual.
- Do not disassemble the inverter. If you need maintenance or repair, take it to a professional service center.
- Improper reassembly may result in electric shock or fire.
- To reduce risk of electric shock, disconnect all wires before attempting any maintenance or cleaning. Turning off the unit will not reduce this risk.
- Caution: Only qualified personnel can install this device with battery.
- Never charge a frozen battery.
- For optimum operation of this inverter, please follow required specification to select appropriate cable size. It is very important to correctly operate this inverter.
- Be very cautious when working with metal tools on or around batteries. Dropping a tool may cause a spark or short circuit in batteries or other electrical parts, even cause an explosion.
- Please strictly follow installation procedure when you want to disconnect AC or DC terminals. Please refer to "Installation" section of this manual for the details.
- Grounding instructions - this inverter should be connected to a permanent grounded wiring system. Be sure to comply with local requirements and regulation to install this inverter.
- Never cause AC output and DC input short circuited. Do not connect to the mains when DC input short circuits.

## 1. SAFETY & WARNING

This manual provides relevant information with icons to highlight the physical and property safety of the user to avoid device damage and physical injury. The Symbols used in this manual are listed as below:

Symbols	Name	Instruction
	Danger	Serious physical injury or even death may occur if not follow the relative requirements
	Warning	Physical injury or damage to the devices may occur if not follow the relative requirements
	Electrostatic sensitive	Damage may occur if not follow the relative requirements
	Hot surface	Sides of the device may become hot. Do not touch.
	Earth terminal	The inverter must be reliably grounded.
	Caution	Ensure that DC and AC side circuit breakers have been disconnected and wait at least 5 minutes before wiring and checking.
NOTE	Note	The procedures taken for ensuring proper operation.
	CE mark	The inverter complies with the CE directive.
	EU WEEE mark	Product should not be disposed as household waste.

## 2. Product Introduction

FelicityESS T-REX-10KLP3G01 is a multifunctional inverter, combining functions of inverter, solar charger and battery charger to offer uninterrupted power support with portable size. Its comprehensive LCD display offers user configurable and easy accessible button operation such as battery charging, AC/solar charging, and acceptable input voltage based on different applications.

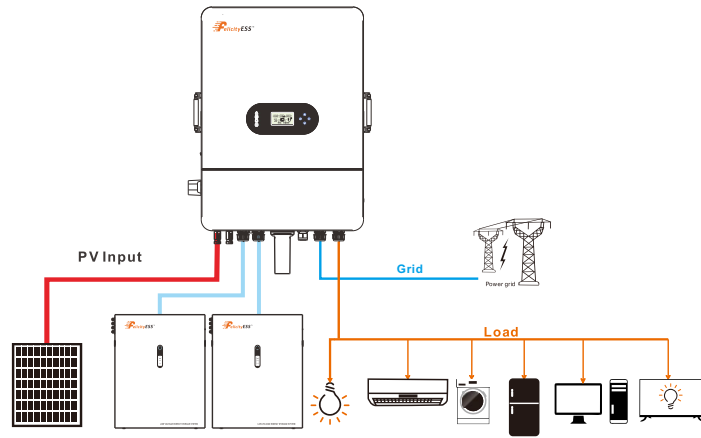


Figure 2.1-1 Block diagram of hybrid solar inverter system

## 2.1 Products overview

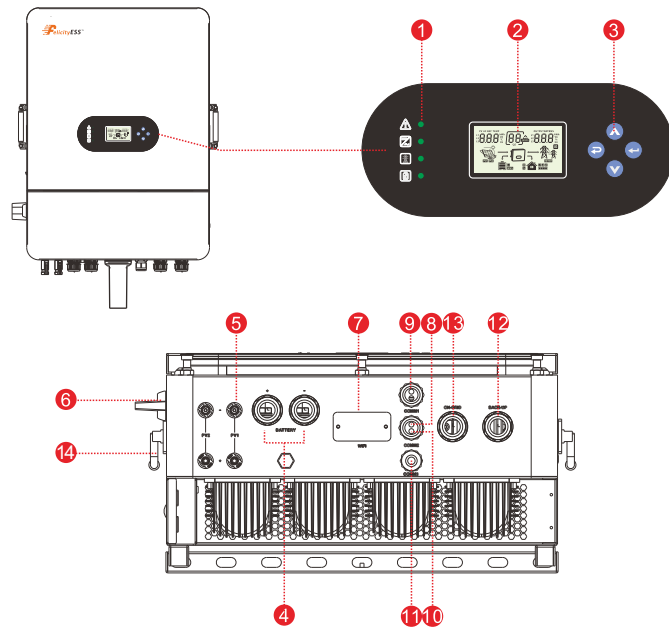


Figure 2.2-1 Products overview

- |                             |                            |                      |
|-----------------------------|----------------------------|----------------------|
| 1. Inverter Indicators      | 6. DC switch               | 10. BMS port         |
| 2. LCD display              | 7. WIFI Communication port | 11. COM port         |
| 3. Button                   | 8. DRMS port               | 12. Back-up terminal |
| 4. Battery connection port  | 9. PARA port               | 13. On-grid terminal |
| 5. PV input connection port |                            |                      |

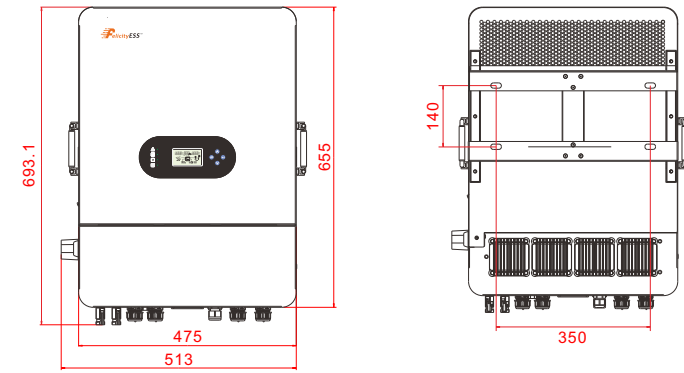


Figure 2.2-2 Inverter dimensions

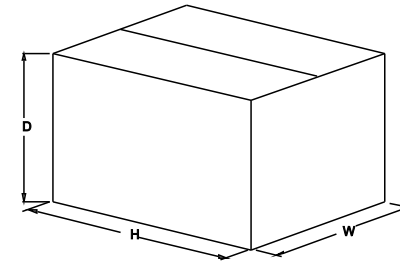


Figure 2.2-3 Paper packages dimension

Table 2-4 Packages dimension and gross weight

Model	H (mm)	W (mm)	D (mm)	Net Weight (KG)	Gross Weight (KG)
T-REX-10KLP3G01	792	597	351	38.9	47.1

### 3 Installation

#### 3.1 Packing List

The inverter 100% strictly inspected before package and delivery. Please check the product package and fittings carefully before installation.

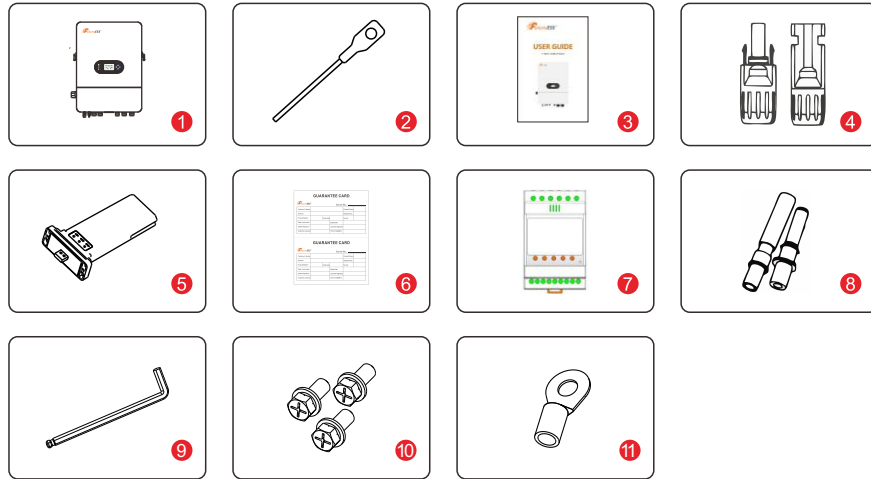


Figure 3.1-1 Packing List

Table 3.1-1 Detailed package list

No.	Name	Quantity
1	Inverter	1
2	battery connector	2
3	Operation manual	1
4	PV connector	2 pairs
5	WiFi module	1
6	Warranty card	1
7	Meter+CT(optional)	1
8	Expansion Bolts	4
9	Allen key	1
10	M5 combination screw	3
11	OT terminals	1

#### 3.2 Installation tools



Figure 3.2-1 Installation tools

#### 3.3 Installation Environment

- ◇ Choose a dry, clean, and tidy place, convenient for installation
- ◇ Ambient temperature range: -25°C ~ 60°C
- ◇ Relative humidity: 0 ~ 100% (non-condensed)
- ◇ Install in a well-ventilated place
- ◇ No flammable or explosive materials close to inverter
- ◇ The AC overvoltage category of inverter is category III
- ◇ Maximum altitude: 2000m



• Inverter cannot be installed near flammable, explosive or strong electro-magnetic equipment.

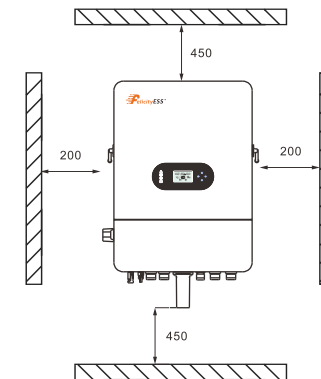


Figure 3.3-1 Installation space of one inverter

Ensure there is sufficient space for heat-releasing. Generally, space requirement should be met as below:

Table 3-3-1 Detailed installation space

	Minimum clearance
Lateral	200mm
Top	450mm
Bottom	450mm

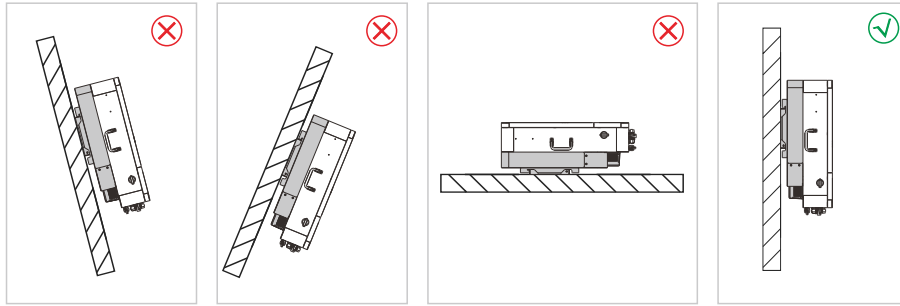


Figure 3.3-2 Installation position



•Do not open the cover of the inverter or replace any part as incomplete inverter may cause electric shock and damage the device during operation.

The installation of inverter should be protected under shelter from direct sunlight or bad weather like snow, rain, lightning etc.

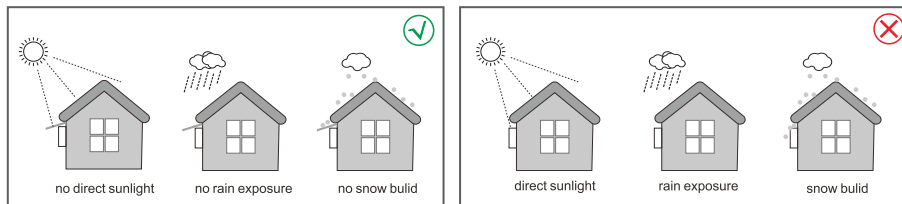


Figure 3.3-3 Installation position

## 3.4 Mounting



•The inverter is heavy, please be careful when removing it from the package.

The inverter is suitable for mounting on concrete or other non-combustible surface only.

**Step 1.** Please use the mounting bracket as a template to drill 4 holes in the right positions (10mm in diameter, and 80mm in depth). Use M8 expansion bolts in accessory box and fix the mounting bracket onto the wall tightly. The installation of inverter support is shown in Figure 3.4-1.

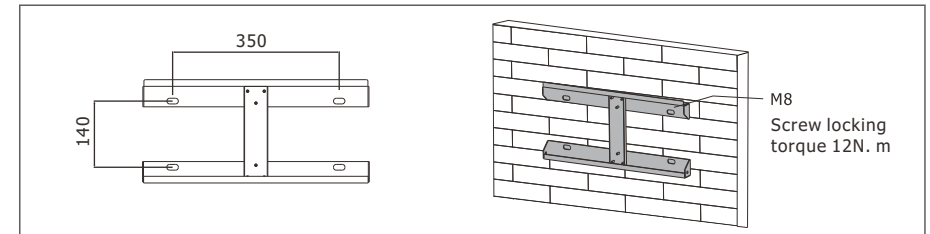


Figure 3.4-1 Install Inverter hanging plate

**Step 2.** Lift the inverter to suspend it on the installation bracket, We can prevent theft by locking. See Figure 3.4-2.

**NOTE**

•Be careful when mounting because the inverter is very heavy.

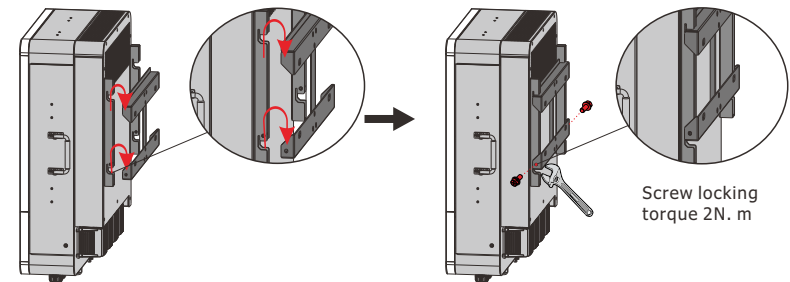


Figure 3.4-2 Installing an Inverter

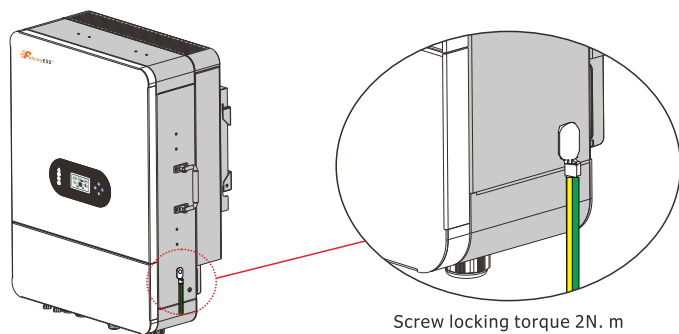


Figure 3.4-3 Rack earth(Ground wire locked by M5)

## 4 Electrical Connection

- ◇ High voltages in power conversion circuits. Lethal hazard of electric shock or serious burns.
- ◇ All work on the PV modules, inverters, and battery systems must be carried out by qualified personnel only.
- ◇ Wear rubber gloves and protective clothing (protective glasses and boots) when working on high voltage/high current systems such as INVERTER and battery systems.

### 4.1 PV Connection

Before connecting PV panels/strings, please make sure requirements are followed as below:

- (1) The total short-circuit current of PV string must not exceed inverter's max DC current.
- (2) The minimum isolation resistance to ground of the PV string must exceed 19.33kΩ in case of any shock hazard.
- (3) PV string could not connect to earth/grounding conductor.
- (4) Use the right PV plugs in the accessory box.

Wire Size (mm <sup>2</sup> )	Cable(mm)
4.0-6.0(12~10AWG)	7

Step 1. Prepare PV positive and negative power cables

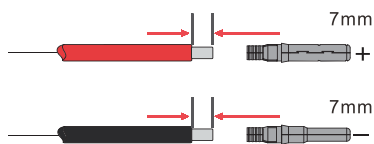


Figure 4.1-1 pv cables and pv plugs

Step 2. Connect PV cables to PV connectors. See Figure 4.1-2.

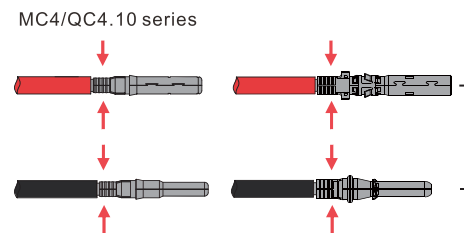


Figure 4.1-2 PV cables to PV connectors

**NOTE**

- PV cables must be tightly crimped into the connectors.
- For Amphenol connector, the limit buckle cannot be pressed.
- There will be a "click" sound if connectors are inserted correctly into PV plugs.

Step 3. Screw the cap on and plug it onto inverter side. There will be a click sound if connectors are inserted correctly into PV plugs. See Figure 4.1-3.

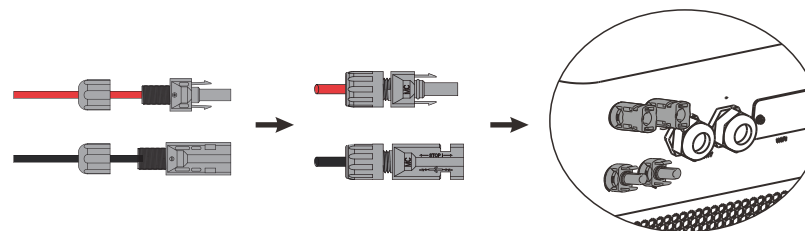


Figure 4.1-3 The PV plug is connected to the inverter



- The polarity of PV strings cannot be connected reversely, otherwise the inverter could be damaged.

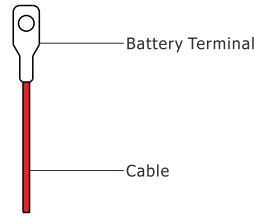
### 4.2 Battery Connection

Please be careful about any electric shock or chemical hazard. Make sure there is an external DC breaker (200A) connected to the battery without build-in DC breaker.

- The polarity of battery cannot be connected reversely, otherwise the inverter could be damaged.

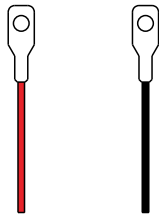
Wire Size (mm <sup>2</sup> )	Cable(mm)
50	15

**Step 1.** Prepare battery cables and accessories, and route the battery power cable through the battery cover. Use accessories box accessories, battery power cable 50mm<sup>2</sup>.



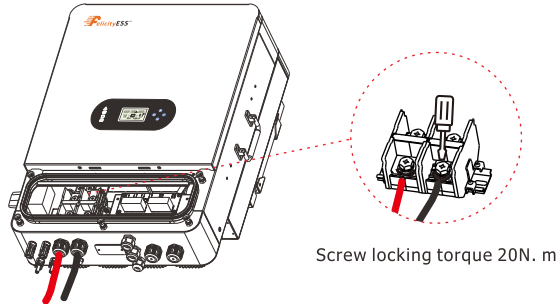
**Figure 4.2-1 Battery cable and battery case**

**Step 2.** Make battery terminals, Strip cable coat, revealing 15mm length of metal core. Use special crimper to compress battery terminal tightly.



**Figure 4.2-2 The battery terminal**

**Step 3.** Connect the battery terminal to the inverter. Ensure that the battery polarity is connected correctly.



**Figure 4.2-3 The battery terminal is connected to the inverter**



•The polarity of Battery cannot be connected reversely, otherwise the inverter could be damaged.

## 4.3 On-Grid & Back-Up Connection

An external AC breaker is needed for on-grid connection to isolate from grid when necessary. The requirements of on-grid AC breaker are shown as below.

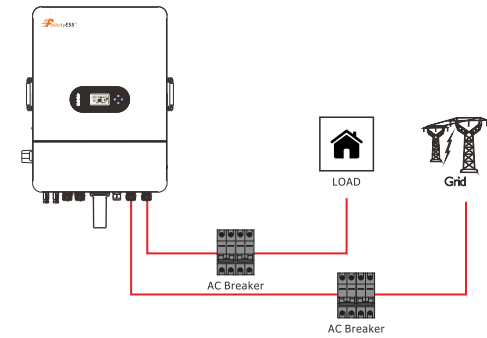
Table 4.3-1 : Recommended table of AC circuit breakers

INVERTER MODEL	AC BREAKER SPECIFICATION
T-REX-10KLP3G01	30A/400V,4P

**NOTE**

• The absence of AC breaker on back-up side will lead to inverter damage if an electrical short circuit happens on back-up side.

1. On the AC side, the individual breaker should be connected between inverter and grid as well as loads. See Figure 4.3-2.



**Figure 4.3-2 Ac breaker connection**



•Make sure the inverter is totally isolated from any DC or AC power before connecting AC cable.

**Step 1.** Prepare the terminals and AC cables according to the right table. See Figure 4.3-3.



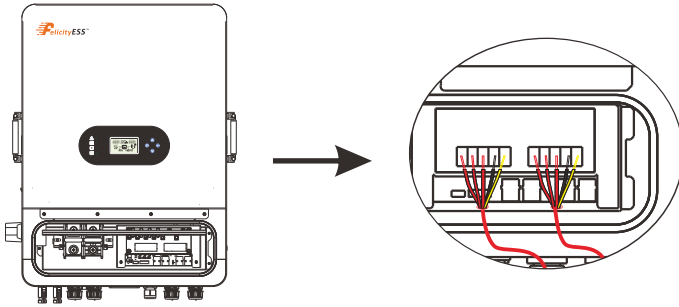
**Figure 4.3-3 Ac connection line**

Table 4.3-2 : Ac cable specifications

Grade	Description	Value
A	Outside diameter	13-18 mm
B	Separated wire length	20-25 mm
C	Conductor wire length	7-9 mm
D	Conductor core section	4-6 mm



**Step2.** Remove insulation sleeve 10mm length, unscrew the bolts, insert the wires according to polarities indicated on the terminal block and tighten the terminal screws. Make sure the connection is complete.

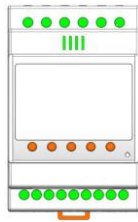


• Don't connect the PE wire wrong.

**NOTE**

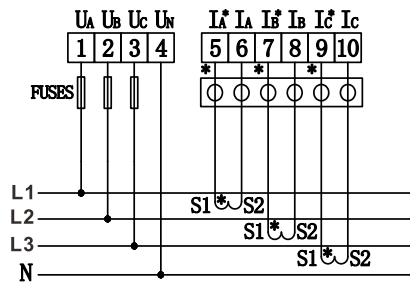
• The absence of AC breaker on back-up side will lead to inverter damage if an electrical short circuit happens on back-up side.

## 4.4 Smart Meter & CT Connection

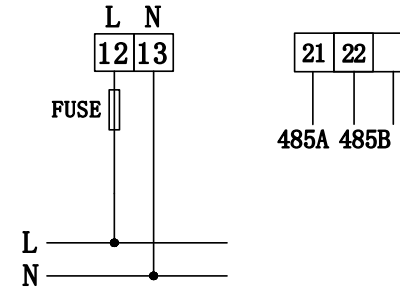


**Figure 4.4-1 Smart Meter**

Signal terminal: "5, 6, 7, 8, 9, 10" is the terminal number of the input current signal;  
 "1, 2, 3, 4" is the terminal number of the input voltage signal;



Auxiliary power supply and communication terminals of the instrument: "12, 13" are the auxiliary power supply terminal numbers, "21, 22" are the communication terminal numbers



• Make sure the inverter is totally isolated from any DC or AC power before connecting AC cable.

The Smart Meter with CT in product box is compulsory for T-REX system installation, used to detect grid voltage and current direction and magnitude, further to instruct the operation condition of T-REX inverter via RS485 communication. See Table 4.4-1.

**Table 4.4-1 :Detailed Pin Function Of COM Port On T-REX**

Position	Function	Note
1	RY1_4	Dry Signal
2	RY1_5	
3	RS485_B3	RS485-3 For Debugging
4	RS485_A3	
5	RS485_A2	RS485-2 For Meter
6	RS485_B2	

Make sure Meter & CT are connected between house loads and grid, and follow the Smart Meter direction sign on CT, refer to Figure 4.4-2.

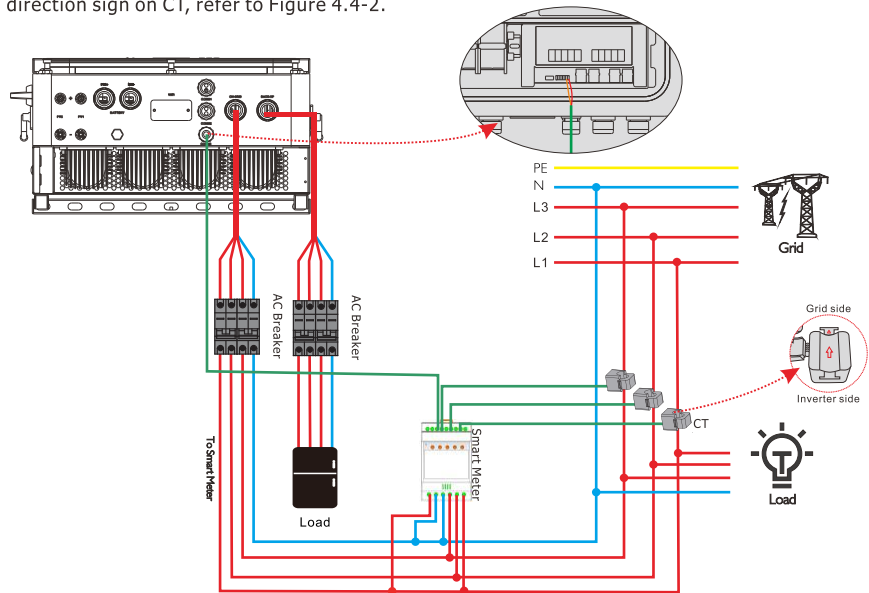


Figure 4.4-2 Smart meter connection

## 4.5 Dry Contact Signal

There is one dry contact (3A/250VAC) available on the inverter.

Unit Status	Condition	Dry contact port
Power Off	Unit is off and no output is powered.	Open
Power On	Battery voltage < Setting value "Battery cut-off voltage of on-grid"	Close
	Battery voltage > Setting value "Battery restart voltage of on-grid"	Open

## 4.6 DRMS Connection

DRMS(Demand response enabling device) is used for Australia and New Zealand installation (also used as remote shutdown function in European countries), in compliance with Australia and New Zealand safety requirements( or European countries). Inverter integrates control logic and provides an interface for DRMS. The DRMS is not provided by inverter manufacturer. Detailed connection of DRMS & Remote Shutdown are shown below:

**Step 1:** Screw this cover off from the inverter. See Figure 4.6-1.

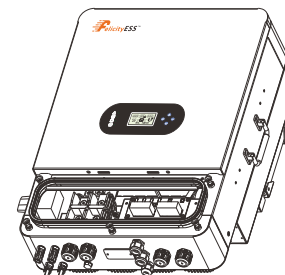


Figure 4.6-1 DRMS interface

**Step 2:** After threading the network cable through the inverter box, make an RJ45 plug according to Table 4.6-1

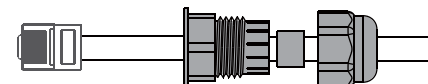


Table 4.6-1 :Port pin allocation table

NO.	1	2	3	4	5	6	7	8
Function	DRM1/5	DRM2/6	DRM3/7	DRM4/8	REF	COM	/	/

**Step 3:** Insert the RJ45 plug into the corresponding position (CN1) according to Figure 4.6-2.

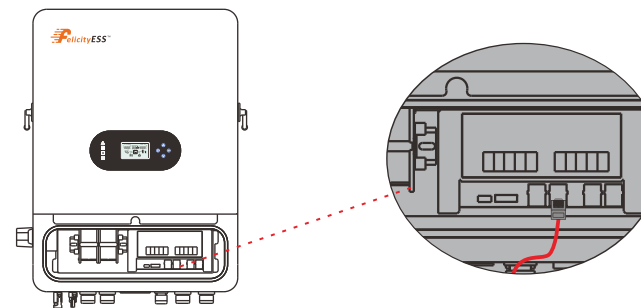
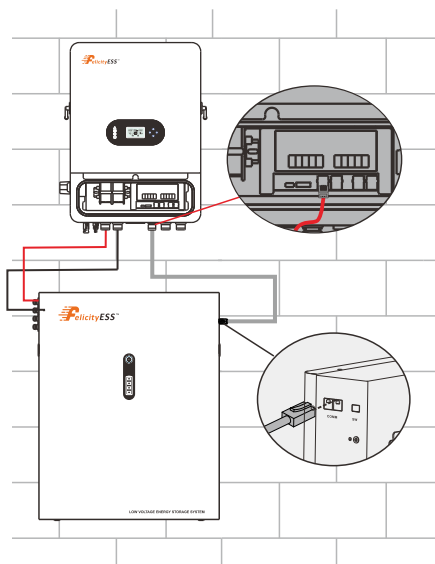


Figure 4.6-5 RJ45 interface

### 4.7 Lithium Battery Communication

It's allowed to connect lithium battery and build communication only which it has been configured. Please follow bellow steps to configure communication between lithium battery and inverter.

1. Connect power cables between lithium battery and inverter. Please pay attention to the terminals of positive and negative. Make sure the positive terminal of battery is connected to the positive terminal of inverter, and the negative terminal of battery is connected to the negative terminal of inverter.
2. The communication cable is bundled with lithium battery. Both sides are RJ45 port. One port is connected to the BMS port of inverter and another one is connected to the COMM port of lithium battery.

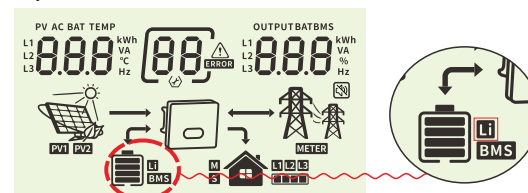


Position	Color	Function
1	Black	/
2	Black	CANL1
3	Black	+VCC
4	Black	COM-GND
5	Black	RS485-B1
6	Black	RS485-A1
7	Black	CANH1
8	Black	/

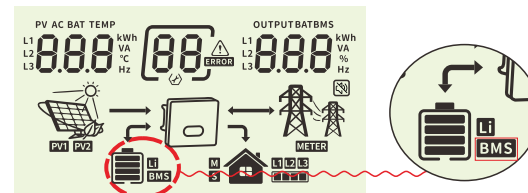
3. Configure battery type to lithium battery on the app



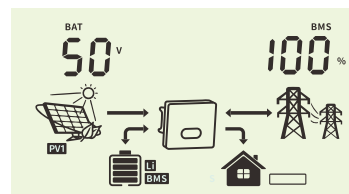
And then LCD will show you "Li" icon.



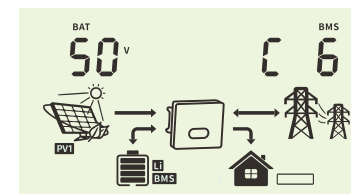
4. Power up lithium battery and inverter. Wait a moment, if the communication is built between them, LCD will show you "BMS" icon as below.



5. Roll LCD real time information pages by pressing "UP" or "DOWN" button, as below page, you can see the parameters of SOC, battery pack units and other informations in the communication system. LCD will be rolled these parameters or informations automatically.



Battery SOC is 100%



Battery pack units are 6

When it displays :

- "b50" means BMS doesn't allow inverter to charge battery
- "b51" means BMS doesn't allow inverter to discharge battery
- "b52" means BMS require inverter to charge battery

### 4.8 Installation of WIFI module

The WiFi communication function applies only to the WiFi module. For details, see Figure 4.8-1 installing a WiFi module.

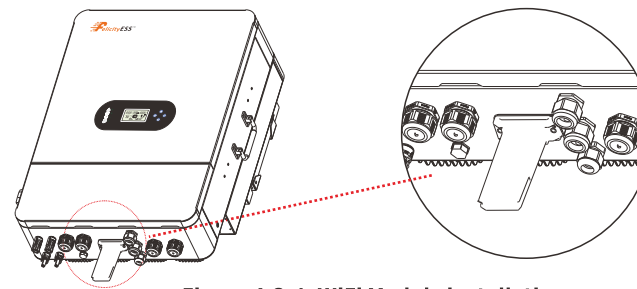


Figure 4.8-1 WiFi Module installation

### 4.9 Wiring System

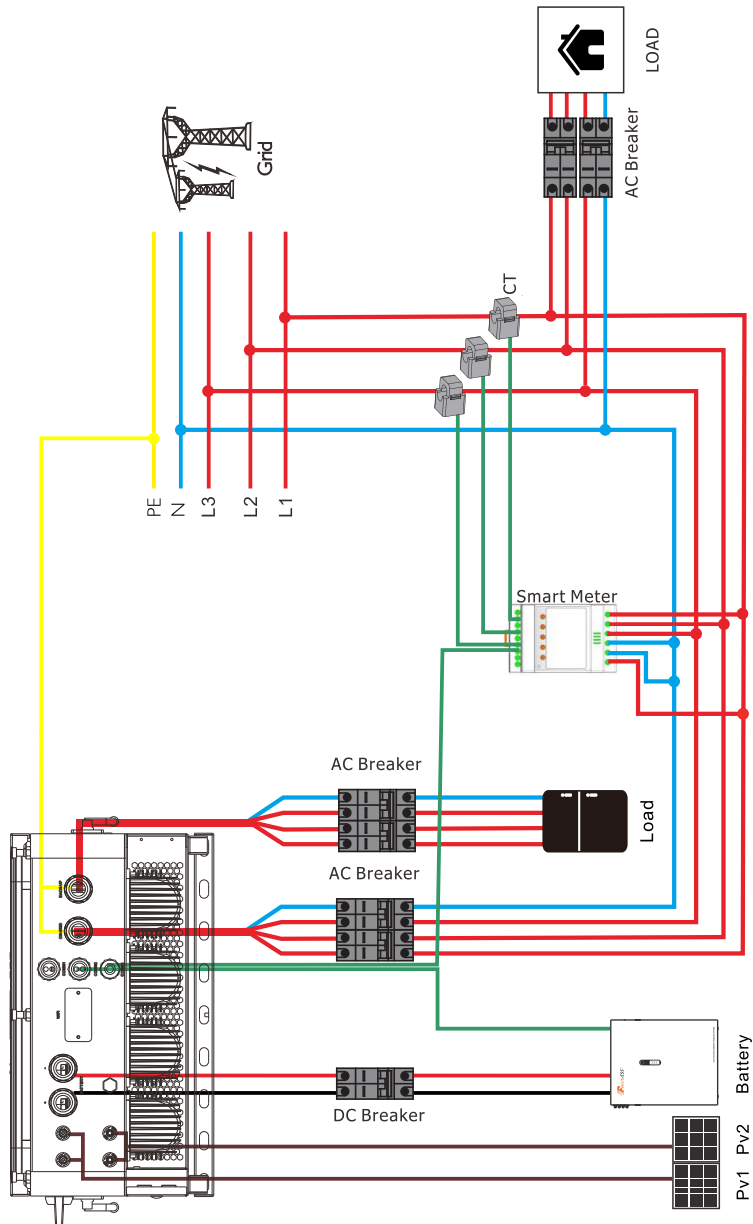
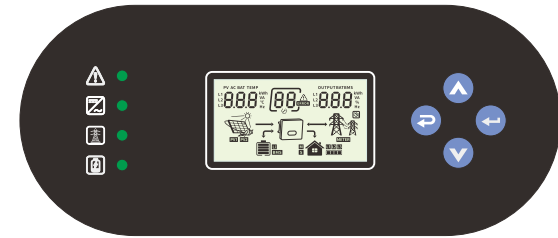


Figure 4.9-1 Inverter wiring system

### 5. Display and operation

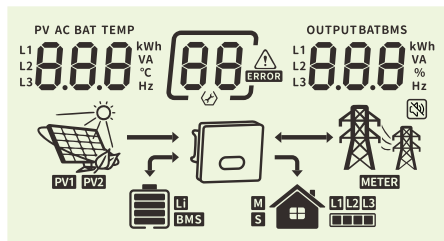
This chapter describes the panel displaying and how to operate on the panel which involves the LCD display, LED indicators and operation panel.

#### 5.1 Operation and Display Panel



Function Key	Icon	Description
ESC		Hold on the "ESC" button last for 3S to turn off the inveter
UP		To go to previous selection
DOWN		To go to next selection
ENTER		Hold on the "ENTER" button last for 3S to turn on the inveter
LED Indicator	Icon	Description
Battery		Charging the battery, the LED light flash. If battery is full, the LED light will always-on. The battery is not charged, the LED light will go out.
Utility		Inverter running in utility mode, the LED will always-on. Inverter is not running in utility mode, the LED will go out.
Inverter		Inverter running in off-grid mode, the LED light will always-on. Inverter is not running in off-grid mode, the LED light will go out.
Fault		If inverter in fault event, the LED light will always-on. If inverter in warning event, the LED light will flash. Inverter work normally, the LED light will go out.
Buzzer Information		
Buzzer beep		Turn on/off the inverter, the buzzer will last for 2.5s. Press any button, the buzzer will last for 0.1s. Hold on the "ENTER" button, the buzzer will last for 3s. If in fault event, the buzzer will keep going. If in warning event, the buzzer will beep discontinuous (Check more information on the chapter of "Warning Code Table").

### 5.2 LCD Display Icons



Icon	Function description
<b>Input Source Information</b>	
	Indicate input voltage, input frequency, PV voltage, PV power, battery voltage and charger current.
<b>Configuration Program and Fault Information</b>	
	Indicates the warning and fault codes. Warning:  flashing with warning code. Fault:  lighting with fault code
<b>Output Information</b>	
	Indicate output voltage, output frequency, load percent, load in VA, load in Watt and discharging current.
<b>Battery Information</b>	
	Indicates battery level by 0-24%, 25-49%, 50-74% and 75-100%.
	Indicates Lithium battery type.
	Indicates communication is built between inverter and battery.
<b>Mode Operation Information</b>	
	Indicates the utility.
	Indicates load level by 1-25%, 26-50%, 51-75% and 76-100%
	Indicates the PV panels.

	Indicates PV MPPT is working.
	Indicates communication is built between inverter and meter
<b>Mute Operation</b>	
	Indicates unit alarm is disabled.

### 5.3 Base information Page

The base information will be switched by pressing "UP" or "DOWN" key. The selectable information is switched as below order:

<b>Phase 1 input voltage/Phase 1 output voltage</b> Input voltage is 230V, output voltage is 230V 	<b>Phase 2 input voltage/Phase 2 output voltage</b> Input voltage is 230V, output voltage is 230V 
<b>Phase 3 input voltage/Phase 3 output voltage</b> Input voltage is 230V, output voltage is 230V 	<b>Input frequency /Phase1 backup load power</b> Utility frequency is 50Hz ,Phase1 backup load is 1.00KW 
<b>Pv1 voltage / Phase2 backup load power</b> Pv1 vottage is 600v,Phase2 backup load is 1.00KW 	<b>Pv1 Power/Phase3 backup load power</b> Pv1 poweris 2.00KW ,Phase3 backup load is 1.00KW 

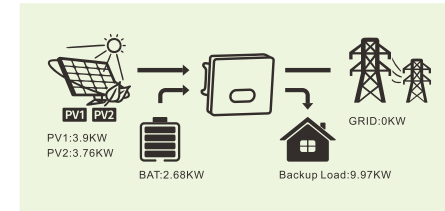
<p><b>Pv2 voltage / Total backup load power</b> Pv2 voltage is 600v , Total backup load is 3.00KW</p>	<p><b>Pv2 Power/Phase1 backup load VA</b> Pv2 power is 2.00KW,Phase1 backup load is 1.00KVA</p>
<p><b>Charging current/Phase2 backup load VA</b> Charging current is 10A .Phase2 backup load is 1.00KVA</p>	<p><b>Battery voltage/ Phase3 backup load VA</b> Batterv voltage is 225V .Phase3 backup load is 1.00KVA</p>
<p><b>Battery voltage/ Total backup load VA</b> Battery voltage is 225V ,total backup load is 3.00KVA</p>	<p><b>Battery voltage/ Output frequency</b> Battery voltage is 225V ,output frequency is 50Hz</p>
<p><b>Battery voltage/ Load percentage</b> Battery voltage is 225V ,load percentage is 30%</p>	<p><b>Battery voltage/ Discharging current</b> Battery voltage is 225V ,Discharging current is 10A</p>
<p><b>Total load power</b> Total load power is 3.00KW</p>	<p><b>CPU software version</b> CPU software version is 200</p>

## 6. Work Mode

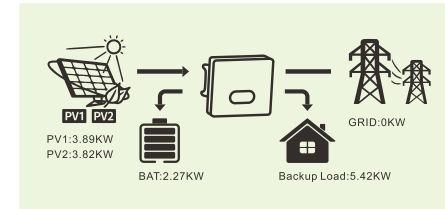
### General mode

In this mode, the priority order of load supply source is Solar>Battery>Grid. The priority order of solar power usage is Load>Battery>Grid.And only solar can charge the battery.

Example1:PV<Load, PV and Bat will load at the same time. If PV+Bat cannot provide sufficient power to the load, the remaining energy will be provided by the Grid.

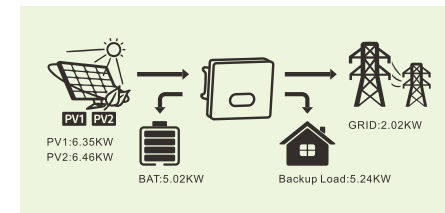


Example2:Load<PV<Load+BAT, PV provides power to Load first and the remaining energy will charge BAT.



Example3:PV>Load+BAT, PV provides power to Load first, and then to BAT, and the remaining energy will be feed to the Grid.

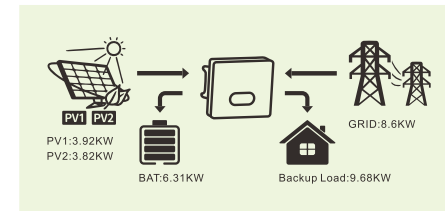
Energy Distribution Priority: Load>BAT>Grid



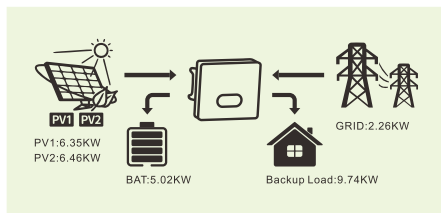
### Backup mode

The priority order of solar power usage will be Battery >Load >Grid. The priority order of load supply source is Solar>Grid>Battery.

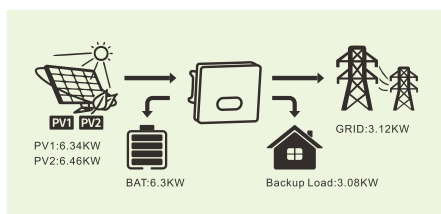
Example1:PV<Load, PV charges BAT first, and the remaining energy required for Load is provided by Grid.



Example2:  $Load < PV < Load + BAT$ , PV charges BAT first, and the remaining energy required for Load will be provided by Grid.



Example3:  $PV > Load + BAT$ , PV provides power to BAT first, and then to Load, and the remaining energy will be feed to the Grid.  
Energy Distribution Priority:  $BAT > Load > Grid$

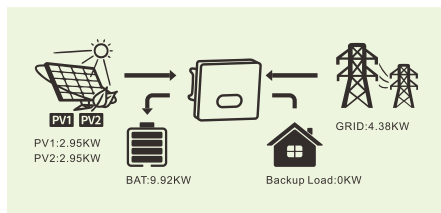


## ECO mode

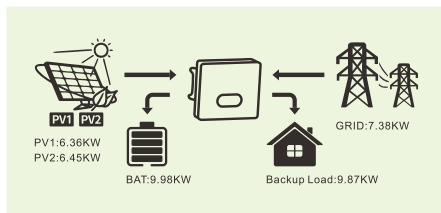
During Charge Priority time period, load is first supplied with grid power. If there is excess solar power after battery charging, the excess solar power will take load together with grid power.  
During Discharge Priority time period, the priority order of load supply source is  $Solar > Battery > Grid$ . If there is excess solar power after load, charging battery, and then feed power to grid.

In charging mode:

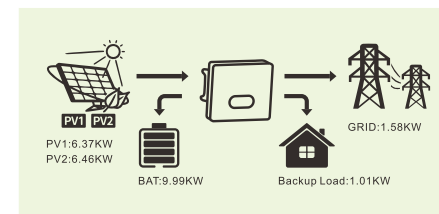
Example1:  $PV < BAT$ , PV+Grid charges BAT, and the Grid will provide power to Load.



Example2:  $BAT < PV < BAT + Load$ , PV charges BAT first, and PV+Grid will provide power to Load.

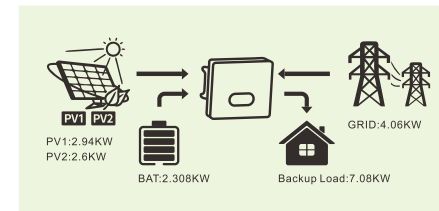


Example3:  $PV > Load + BAT$ , PV provides power to Load and BAT, and the remaining energy will be sent to the Grid.

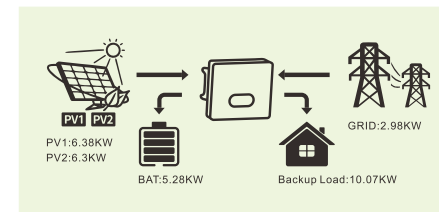


In discharging mode:

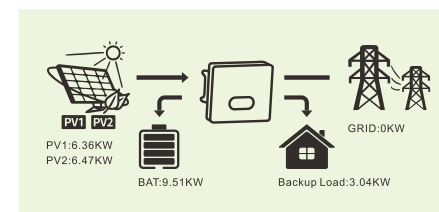
Example1:  $PV < Load$ , PV+BAT provide power to Load, BAT provides power to the Grid.



Example2:  $Load < PV < Load + BAT$ , PV provides power to Load first, PV+BAT will provide power to the Grid.



Example3:  $PV > Load + BAT$ , PV provides power to Load and Grid, and the remaining energy will charge BAT.



## Power Limit Function

The function could be realized by:

- (1) Make sure Smart Meter connection and communication well.
- (2) Turn on export power limit function and set the max output power to grid on App.


Note: Even if output power limit is set to 0W, there might still be a deviation of a max of 100W exporting to grid.

**Zero Export To Load:** Hybrid inverter will provide power to the backup load connected. The hybrid inverter will also provide power to the home load and sell power to grid by the function of Grid Power Limit setting. Smart Meter & CT Connection is not needed.

**Zero Export To CT:** Hybrid inverter will not only provide power to the backup load connected but also give power to the home load connected. If PV power and battery power is insufficient, it will take grid energy as supplement. In this mode, a Meter&CT is needed. The installation method of the Meter&CT please refer to chapter 4.4 Smart Meter & CT Connection.

**Grid Power Limit:** the maximum power feeds to Grid.

## 7.Warning Code Table

When fault event happens, the fault LED is flashing. At the same time, warning code, icon  is shown on the LCD screen.

Warning Code	Warning Information	Audible Alarm	Trouble Shooting
07	Low battery		The battery voltage is too low, it should be charging.
09	Overload	Beep twice every second	Reduce the loads.
51	BMS doesn't allow inverter to discharge battery.		Inverter will stop discharging battery automatically.
52	BMS require inverter to charge battery.		Inverter will charge battery automatically.
60	BMS firmware version is not matched.		Upgrade the firmware of BMS.
91	The number of battery packs in series has not been set		Please set it correctly according to the number of battery packs used by the inverter

## 8.Troubleshooting

This chapter describes the fault alarm and fault code for quick troubleshooting.

Table 7-1 Fault code

Fault Code	Fault information	Trouble Shooting
01	PV voltage is too high	Reduce the number of Pv modules in series.
02	Over current happen at PV port	Restart the unit, if the error happens again, please return to repair center.
04	Stort circuit happen at PV port	Check if wiring is connect well.
07	Battery voltage is too high	Check if spec and quantity of batteries are meet requirements.
08	Over current happen at Battery	Restart the unit, if the error happens again, please return to repair center.
11	Over current happen at Buckboost	Restart the unit, if the error happens again, please return to repair center.
13	Buckboost soft start failed	Restart the unit, if the error happens again, please return to repair center.
15	Buckboost current sensor failed	Restart the unit, if the error happens again, please return to repair center.

17	Overload time out	Reduce the connected load by switching off some equipment.
18	The output overcurrent is abnormal	Restart the unit, if the error happens again, please return to repair center.
19	Output short circuited	Check if wiring is connected well and remove abnormal load.
21	OP current sensor failed	Output current sensor failed
22	Output voltage is too low	Reduce the connected load.
23	Output voltage is too high	Restart the unit, if the error happens again, please return to repair center.
24	Over current or surge detected by Software	Restart the unit, if the error happens again, please return to repair center.
25	Hardware detect over current at inverter port	Restart the unit, if the error happens again, please return to repair center.
26	Invert soft start failed	Internal components failed. Restart the unit, if the error happens again, please return to repair center.
28	The DC component of the inverter current is abnormal	Restart the unit, if the error happens again, please return to repair center.
29	Inverter current sensor failed	Restart the unit, if the error happens again, please return to repair center.
30	Bus voltage is too low	Restart the unit, if the error happens again, please return to repair center.
31	Bus voltage is too high	AC Surge or internal components failed. Restart the unit, if the error happens again, please return to repair center.
32	Bus voltage unbalance	Restart the unit, if the error happens again, please return to repair center.
33	Bus soft start failed	Internal components failed. Restart the unit, if the error happens again, please return to repair center.
34	Over temperature happen at heat sink	Check whether the ambient temperature is too high.
35	The inner temperature over	Check whether the ambient temperature is too high.
38	Leakage current fault	Restart the unit, if the error happens again, please return to repair center.
39	Leakage current sensor failed	Restart the unit, if the error happens again, please return to repair center.
40	Isolation resistance to ground of the PV string is too low	Restart the unit, if the error happens again, please return to repair center.



41	Grounding errors	1.Confirm correct grounding. 2.Restart the unit, if the error happens again, please return to repair center.
42	Relay check failure	Restart the unit, if the error happens again, please return to repair center.
43	CAN data loss	1.Check if communication cables are connected well and restart the inverter. 2.If the problem remains, please contact your installer.
44	Host data loss	
45	Synchronization data loss	
46	The firmware version of each inverter is not the same.	1.Update all inverter firmware to the same version. 2.Check the version of each inverter via LCD setting and make sure the CPU versions are same. If not, please contact your installer to provide the firmware to update. 3.After updating, if the problem still remains, please contact your installer.
47	The inverter Settings are inconsistent	1.Through the LCD control button on the inverter, the parameters of the machine are set to the same as those of other machines. 2.If the problem persists, contact the after-sales service
48	Parallel installation is abnormal	Contact after-sales service for installation technical guidance
49	Parallel negative power protection	Restart the unit, if the error happens again, please return to repair center.
50	EEPROM failure	Restart the unit, if the error happens again, please return to repair center.
51	DSP1 communication failure	Restart the unit, if the error happens again, please return to repair center.
52	DSP2 communication failure	Restart the unit, if the error happens again, please return to repair center.
87	Battery input circuit failure	Restart the unit, if the error happens again, please return to repair center.
91	The number of battery packs in series has not been set	Please set it correctly according to the number of battery packs used by the inverter

## Appendix

Model	T-REX-10KLP3G01
<b>Battery Input Data</b>	
Battery Voltage Range	40V~60V
Max. charging and discharging current	200A/200A
Max. charging and discharging power	10000W
Battery type	Li-Ion /Lead-acid
<b>DC Input Data (PV side)</b>	
Max. recommended PV power	13000W
Max. PV voltage	900V
Start voltage	180V
PV voltage range	160V~900V
MPPT voltage range	200V~850V
MPPT Voltage Range for Full Load	450v-850v
Nominal voltage	720V
Max. input current	15A/15A
Max. shorted curent	18A/18A
Number of MPP trackers / strings per MPP tracker	2/1
<b>Grid Data</b>	
Nominal Input Voltage	L1/L2/L3/N/PE, 230/400Vac
Input Voltage Range	184~264.5Vac*
Nominal grid frequency	50/60Hz*
Max. input current	30A
Max. Charge Current	200A
Max. AC output power	10000W
AC Output Rated Current	14.5A
Max. output current	18A
Max. Continuous AC Passthrough	30A
Power factor	>0.99
Displacement power factor	0.8leading...0.8lagging
THDI	<3%
<b>AC Output Data(Back Up)</b>	
Rated output power	10000VA/10000W
Max. Output current	30A
Rated AC output voltage	L1/L2/L3/N/PE, 230/400Vac
Rated AC output frequency	50/60Hz

Efficiency	
Max. efficiency	97.6%
Euro efficiency	97.0%
MPPT efficiency	99.9%
Protection	
Output over current protection	Integrated
Output over power protection	Integrated
Output shorted protection	Integrated
Anti-islanding protection	Integrated
GFCI Protection	Integrated
Insulation Resistor Detection	Integrated
General Data	
Operating temperature range	- 25°C~60°C, >45°C Derating
Protection degree	IP65
Relative humidity	100%
Cooling concept	Smart cooling
Altitude	2000m
Communication	RS232/RS485
BMS Communication	CAN/RS485
Monitor module	WiFi/GPRS
Display	LCD+LED
Installation Style	Wall-mounted
Warranty [1]	10 years
Grid Regulation	VDE-AR-N 4105; G99/1; EN50549-1; CEI 0-21; AS 4777.2; NRS 097-2-1;
Safety Regulation	IEC 62109-1/2 , IEC 62040-1
EMC	EN61000-6-1 , EN61000-6-3
Net Weight	38.9KG
Gross Weight	47.1KG
Product Dimension	655*475*266MM
Package Dimension	792*597*351MM
[1] Conditions apply, refer to FelicityESS Warranty policy.	

\* According to local grid-connected standards

**Features:**

- Support WiFi for mobile monitoring
- Max.charging/discharging current of 200A
- AC couple to retrofit existing solar system
- Support storing energy from diesel generator
- Power supply can be switched automatically and switching time within 20ms